



INSTRUCTION MANUAL



MODEL **TR-4C** SIDE BAND TRANSCEIVER

TABLE OF CONTENTS

	Page
CHAPTER I	INTRODUCTION 1-1
1-1.	GENERAL DESCRIPTION 1-1
1-2.	MANUAL COVERAGE 1-1
	SPECIFICATIONS 1-3
CHAPTER II	INSTALLATION. 2-1
2-1.	UNPACKING 2-1
2-2.	LOCATION 2-1
2-3.	MOBILE INSTALLATION 2-1
2-4.	POWER REQUIREMENTS 2-1
2-5.	MOUNTING 2-1
2-6.	ANTENNA. 2-1
2-7.	SPEAKER 2-1
2-8.	MICROPHONE 2-1
2-9.	STATIONARY INSTALLATION 2-2
2-10.	POWER REQUIREMENTS 2-2
2-11.	VIEWING ANGLE 2-2
2-12.	ACCESSORIES 2-2
CHAPTER III	OPERATION 3-1
3-1.	GENERAL. 3-1
3-2.	MODE SWITCH 3-1
3-3.	BLANKER SWITCH 3-1
3-4.	VFODIAL. 3-1
3-5.	TUNING PROCEDURE 3-1
3-6.	BIAS ADJUSTMENT 3-1
	FRONT PANEL CONTROLS 3-3
	OTHER CONTROLS 3-4
3-7.	TUNE UP 3-5
3-8.	SSB OPERATION 3-5

TABLE OF CONTENTS (continued)

		Page
3-9.	CW OPERATION.	3-6
3-10.	AM OPERATION	3-6
3-11.	OPERATION NEAR BAND EDGES	3-6
3-12.	OPERATION WITH A LINEAR AMPLIFIER	3-6
3-13.	NOVICE OPERATION.	3-7
CHAPTER IV	THEORY OF OPERATION.	4-1
4-1.	GENERAL.	4-1
4-2.	RECEIVER CIRCUITRY	4-1
4-3.	TRANSMITTER CIRCUITRY	4-2
CHAPTER V	MAINTENANCE.	5-1
5-1.	SERVICE DATA.	5-1
5-2.	TOP COVER REMOVAL	5-1
5-3.	BOTTOM COVER REMOVAL	5-1
5-4.	TUBE REPLACEMENT	5-1
5-5.	TROUBLE SHOOTING	5-1
5-6.	TEST EQUIPMENT.	5-2
5-7.	ALIGNMENT PROCEDURES	5-2
5-8.	CRYSTAL CALIBRATOR	5-2
5-9.	9.0 MHz OSCILLATOR	5-2
5-10.	INJECTION CRYSTAL OSCILLATOR	5-2
5-11.	VFO ADJUSTMENT	5-2
5-12.	INJECTION COUPLER	5-2
5-13.	RECEIVER IF	5-5
5-14.	BALANCED MODULATOR AND CARRIER BALANCE	5-5
5-15.	FILTER MATCHING TRANSFORMER	5-6
5-16.	MIXER AND IF ALIGNMENT	5-6
5-17.	PA NEUTRALIZATION	5-6
5-18.	TRANSMITTER NEUTRALIZATION.	5-6
5-19.	S METER ADJUSTMENT.	5-6

LIST OF ILLUSTRATIONS

Figure		Page
1-1.	TR-4C SIDEBAND TRANSCEIVER	1 - 2
2-1.	MICROPHONE CONNECTIONS	2 - 1
2-2.	REAR CHASSIS CONNECTORS	2 - 2
2-3.	ELECTRICAL CONNECTIONS REQUIRED FOR MOBILE INSTALLATION	2 - 3
2-4.	MOBILE INSTALLATION MOUNTING OPTIONS	2 - 4
2-5.	VIEWING ANGLE OPTIONS IN A STATIONARY INSTALLATION	2 - 5
2-6.	CONNECTING THE AC-4 POWER SUPPLY AND MS-4 SPEAKER	2 - 5
2-7.	CONNECTING THE AC-4 POWER SUPPLY, RV-4C REMOTE VFO AND A LINEAR AMPLIFIER	2 - 6
2-8.	CONNECTING THE AC-4 POWER SUPPLY AND THE L-4B LINEAR AMPLIFIER	2 - 6
2-9.	CONNECTING AN EXTERNAL RECEIVER	2 - 7
3-1.	FRONT PANEL CONTROLS	3 - 2
4-1.	BLOCK DIAGRAM	4 - 4
5-1.	ALIGNMENT LOCATIONS, TOP VIEW	5 - 8
5-2.	ALIGNMENT LOCATIONS, BOTTOM VIEW	5 - 9
5-3.	AC-4 POWER SUPPLY SCHEMATIC.	5-11
5-4.	DC-4 POWER SUPPLY SCHEMATIC.	5-11
5-5.	TR-4C SCHEMATIC	5-1 1

CHAPTER I

INTRODUCTION

I-1. GENERAL DESCRIPTION.

The TR-4C is a 300 Watt HF single sideband transceiver which covers the 80 through 10 meter amateur bands. AM and CW modes are also included. The TR-4C requires either an R. L. Drake AC-4, 120 V AC power supply, or an R. L. Drake DC-4, 12 V DC power supply. The TR-4C features a high-stability linear permeability tuned VFO and two 8 pole crystal lattice filters for sideband selection. Available accessories include an RV-4C Remote VFO, a matching MS-4 Speaker, an FF-1 Fixed Frequency Adapter, a 34-PNB Noise Blanker,

an **MC-4** Mobile Console, and a TR-4C VHF Modification Kit.

1-2. MANUAL COVERAGE.

This manual provides sufficient information for operation of the TR-4C Transceiver by a licensed operator and for repair and maintenance by an experienced electronics technician. Chapter II provides installation instructions and illustrates interconnection with accessories. Chapter III describes operation procedures. Chapter IV presents theory of operation supported by a block diagram. Chapter V provides maintenance instructions and parts ordering information.



Figure 1-1. TR-4C Sideband Transceiver

SPECIFICATIONS

GENERAL:

Frequency Coverage:	3.5 to 4.1 MHz, 7.0 to 7.6 MHz, 13.9 to 14.5 MHz, 21.0 to 21.6 MHz and 28.5 to 29.1 MHz; accessory crystals are available for the 28.0 to 28.6 MHz and 29.1 to 29.7 MHz segments of the 10 meter band.
Mode of Operation:	Lower Sideband, Upper Sideband, AM and CW.
Frequency Stability:	Total drift is less than 100 Hz after warm up. Total frequency change is less than 100 Hz for a +10% line voltage change.
Power Supply Requirements:	+ 650 Volts DC at 300 mA average and 500 mA maximum with 10% regulation from 100 to 500 mA and a maximum ripple 1%. + 250 Volts DC at 200 mA with 10% regulation from 170 mA to 200 mA. This includes the effect of the 650 Volt supply change if both voltages are obtained from the same transformer. Maximum ripple must be less than 1/4%. -45 to -65 Volts DC adjustable filtered bias into 33 K Ohm load. 12.6 Volts AC or DC at 5.5 Amperes.
Antenna Impedance:	Nominal 52 Ohms (VSWR less than 2: 1).
Dial Calibration:	Better than +1 kHz when calibrated at the nearest 100 kHz calibration point.
Dimensions:	5.5 in. High x 10.75 in. Wide x 14.375 in. Deep. 13.97 cm. High x 27.31 cm. Wide x 36.51 cm. Deep.
Weight:	16 lbs. (7.26 kg.)
RECEIVER:	
Sensitivity:	Less than 0.5 μV for 10 dB $\frac{S+N}{N}$
AGC:	Less than 3 dB variation for 60 dB change in input signal.
Selectivity:	2.1 kHz at -6dB and 3.4 kHz at -60 dB.
IF Frequency:	9 MHz.
Audio Output:	3 Watts with less than 10% distortion.
Output Impedance:	4 Ohms.
TRANSMITTER:	
Power Input:	300 Watts PEP SSB, 260 Watts CW and 260 Watts PEP AM.
Output Impedance:	Nominal 52 Ohms.
Average Distortion Products:	The odd order products are down 30 dB below PEP.
Microphone Input:	High Impedance.

CHAPTER II INSTALLATION

2-1. UNPACKING.

Carefully remove the unit from the shipping carton and examine it for evidence of damage. If any damage is discovered, immediately notify the transportation company that delivered the unit. Be sure to keep the shipping carton and packing material as the transportation company will want to examine them if there is a damage claim. Keep the carton and packing material even if no shipping damage occurs. Having the original carton available makes packing the unit much easier if it should ever be necessary to store it or return it to the factory for service.

NOTE

Fill out the enclosed registration card and return it to the factory immediately to insure registration and validation of the warranty.

2-2. LOCATION.

The location of the TR-4C is not critical. However, care should be taken to insure that adequate clearance is provided to insure free circulation of air around the unit and to allow access to the side controls and connectors. Do not cover the top of the cabinet with books, papers or other equipment as overheating may result.

2-3. MOBILE INSTALLATION.

2-4. POWER REQUIREMENTS. Refer to figure 2-2 for rear chassis connector identification. The TR-4C may be installed in any vehicle with a 12 volt dc negative ground system. An R. L. Drake Model DC-4 Power Supply is required for a mobile installation. The recommended location for the DC-4 is on the passenger side of the firewall. Refer to figure 2-3 for the electrical connections required.

2-5. MOUNTING. Mount the TR-4C in a convenient location below the dash with an R. L. Drake

Model MMK-3 Mobile Mounting Kit. Refer to figure 2-4 for various mounting options. Be sure to allow adequate clearance for air circulation and cable connections. Turn the TR-4C off. Connect the power cable between the TR-4C and the DC-4. Coil up any excess cable and tape it in place out of sight. Connect the black wire from the power supply to a convenient ground. Route the red wire from the power supply through the firewall and connect it to the positive battery terminal or the starter solenoid. The fuse holder should be installed as close to the solenoid as possible. Shorten both of these wires as much as possible.

2-6. ANTENNA. Install a mobile antenna as recommended by the antenna manufacturer. Connect a coaxial cable from the antenna to the SO-239 connector at the rear of the TR-4C.

2-7. SPEAKER. *DO NOT* connect the TR-4C to the speaker of the car radio. Install a separate speaker for use with the TR-4C. The R. L. Drake Model MC-4 Mobile Console is recommended for this type of installation. It includes a speaker and a wattmeter and is designed to mount over or under the TR-4C.

2-8. MICROPHONE. Use a microphone with a flat frequency response. The microphone should have a cardioid pattern to reduce pickup from the back and sides. Connect the microphone as illustrated in figure 2-1 to insure proper performance.

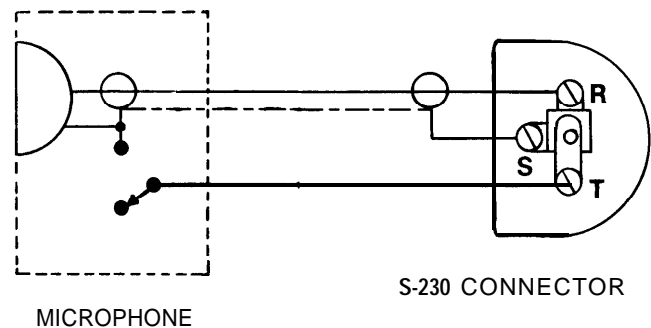

Figure 2-1. Microphone Connections

2-9. STATIONARY INSTALLATION.

2-10. POWER REQUIREMENTS. An R. L. Drake Model AC-4 Power Supply rated at 120 volts ac, 50/60 Hz, is required for stationary installations. The AC-4 is designed to fit inside the MS-4 speaker cabinet.

2-1 1. VIEWING ANGLE. Refer to figure 2-5 for illustrations of viewing angle options. See Chapter V for bottom cover removal.

2-1 2. ACCESSORIES. Refer to figures 2-6 through 2-9 for the electrical connections required to operate the TR-4C with the various recommended accessories.

NOTE

If the old RV-3 is to be used it must be modified as follows: Install a 22 K, 2 Watt resistor from pin 1 of the tube (OA2) to the terminal of the FUNCTION switch to which the orange wire is attached.

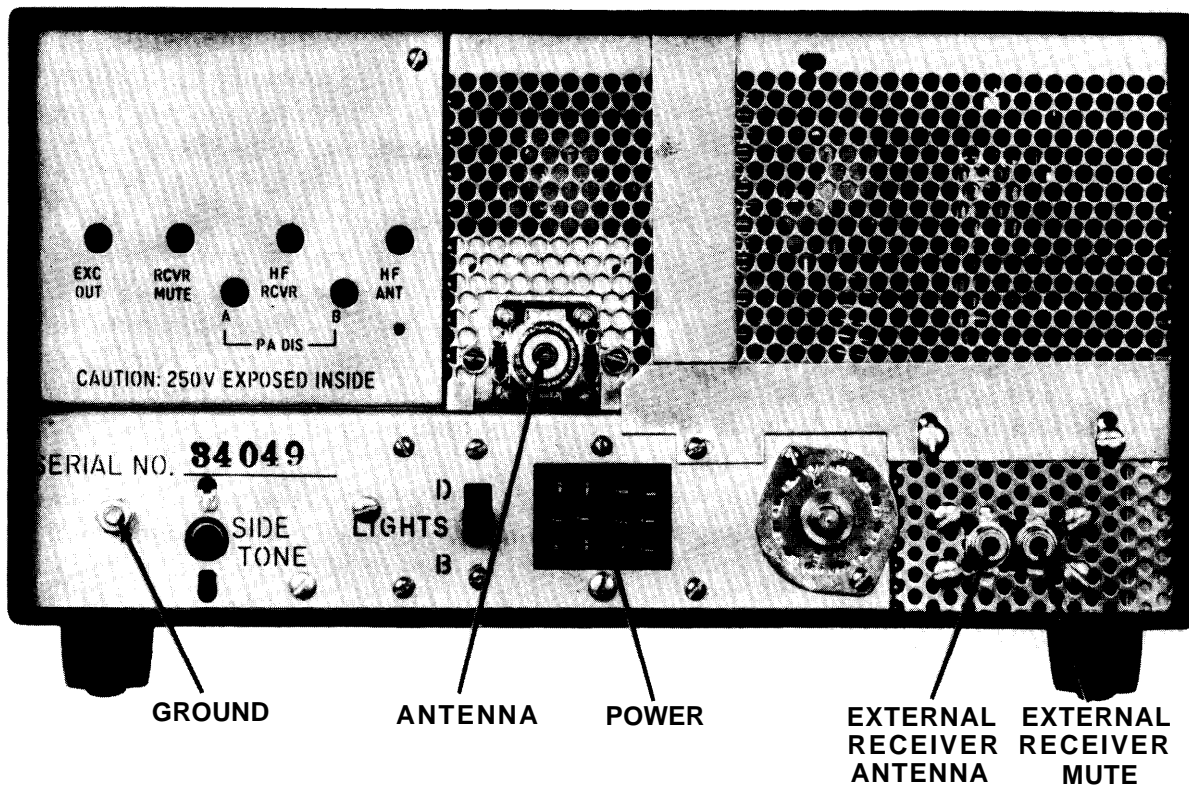

Figure 2-2. Rear Chassis Connectors

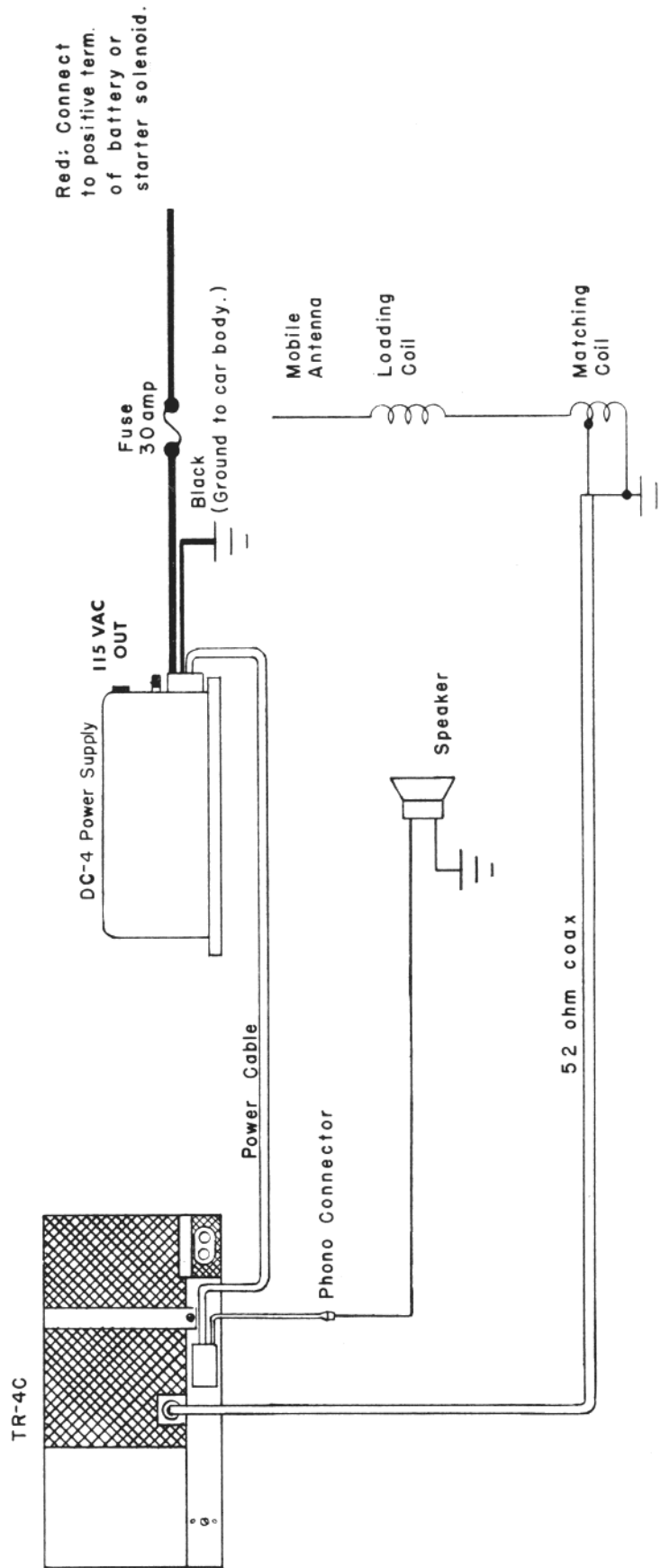
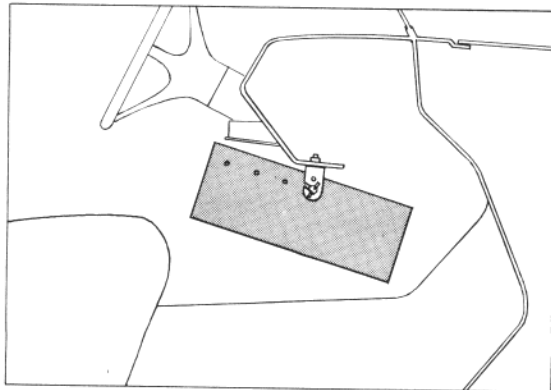
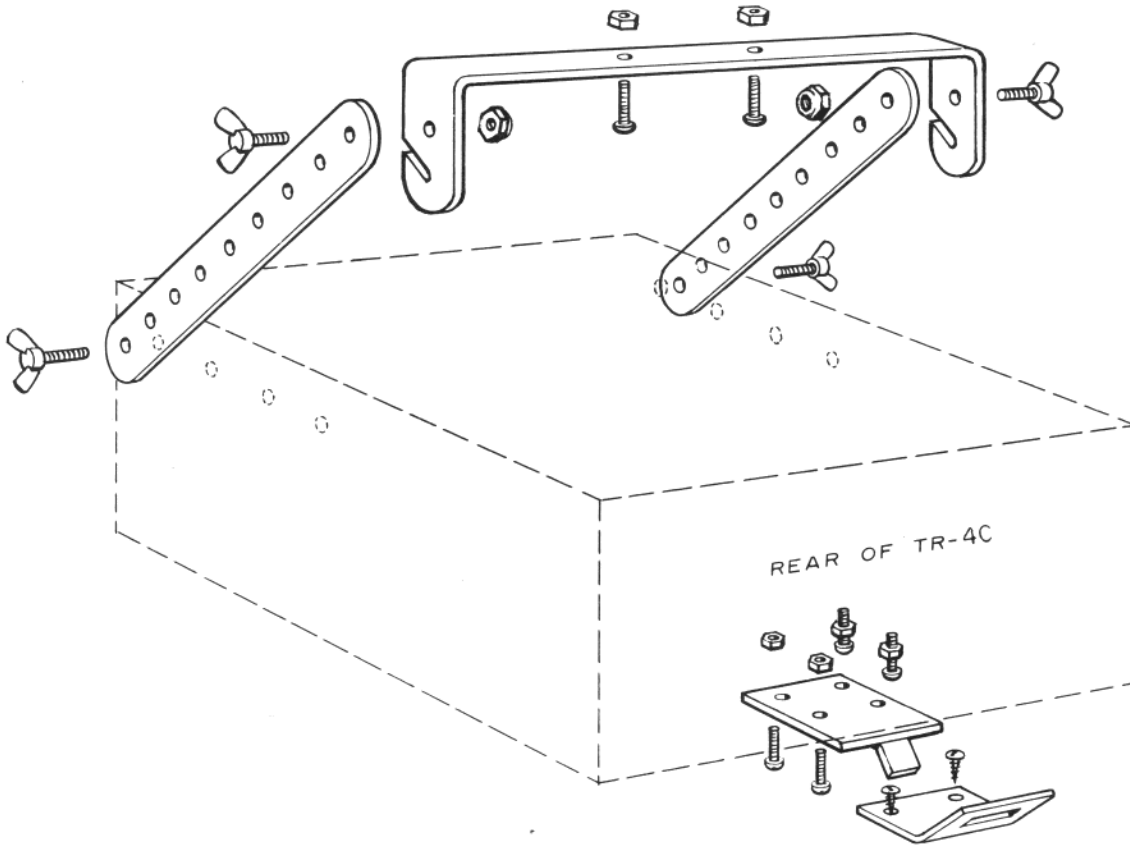
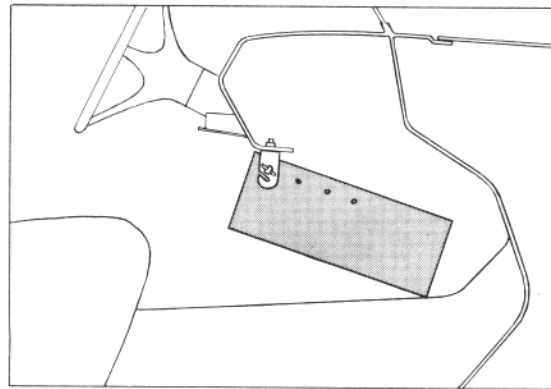

Figure 2-3. Electrical Connections Required for Mobile Installation



OPTION A



OPTION B

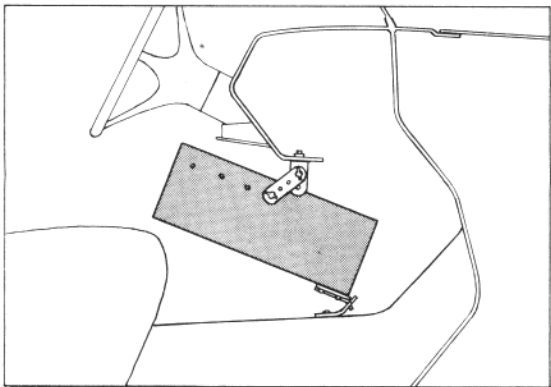

OPTION C

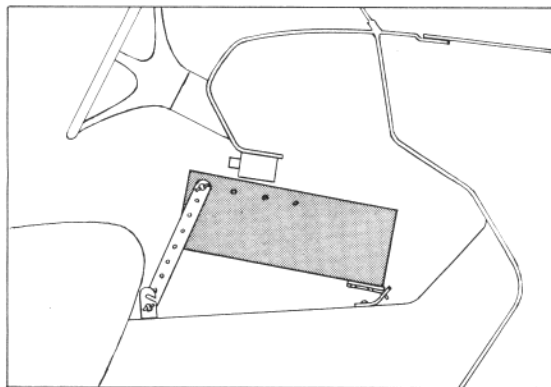

OPTION D

Figure 2-4. Mobile Installation Mounting Options

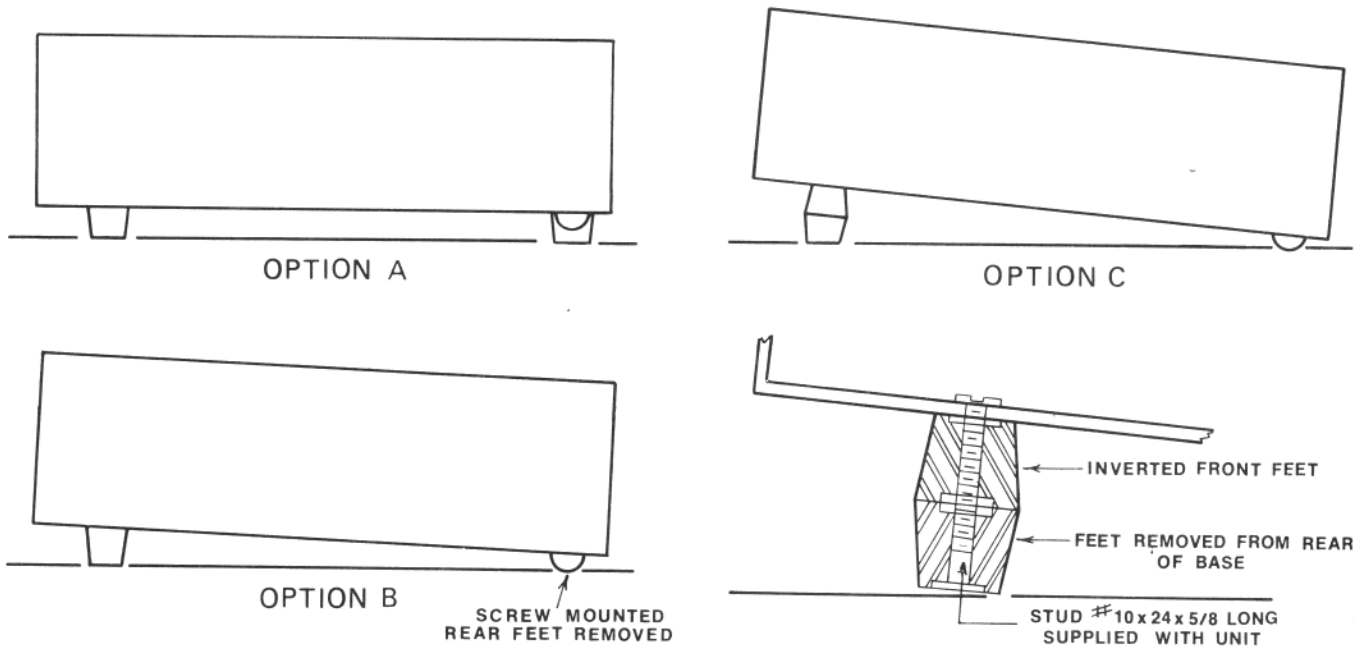

Figure 2-5. Viewing Angle Options in a Stationary Installation

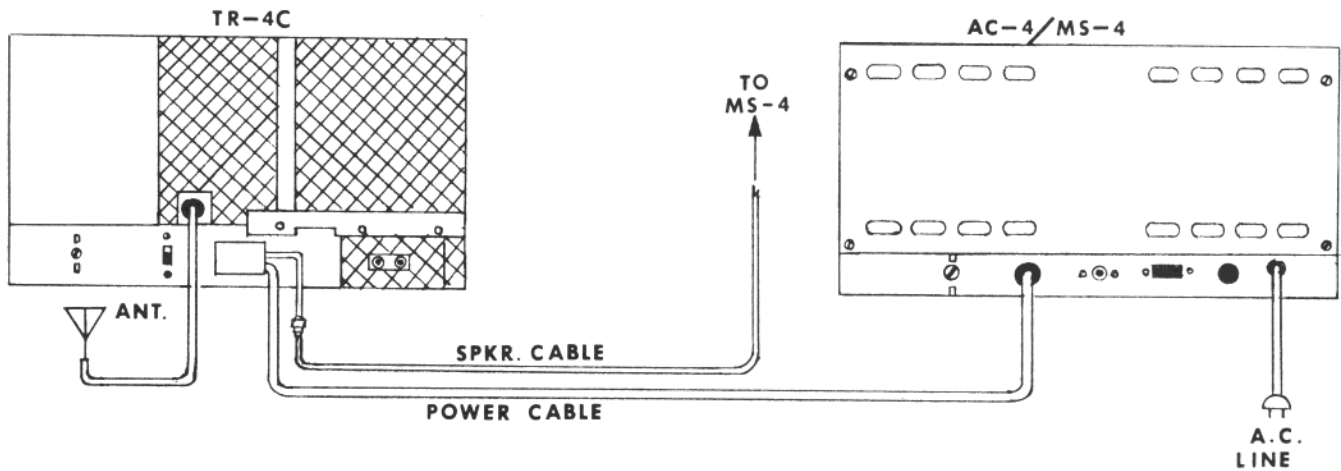

Figure 2-6. Connecting the AC-4 Power Supply and MS-4 Speaker

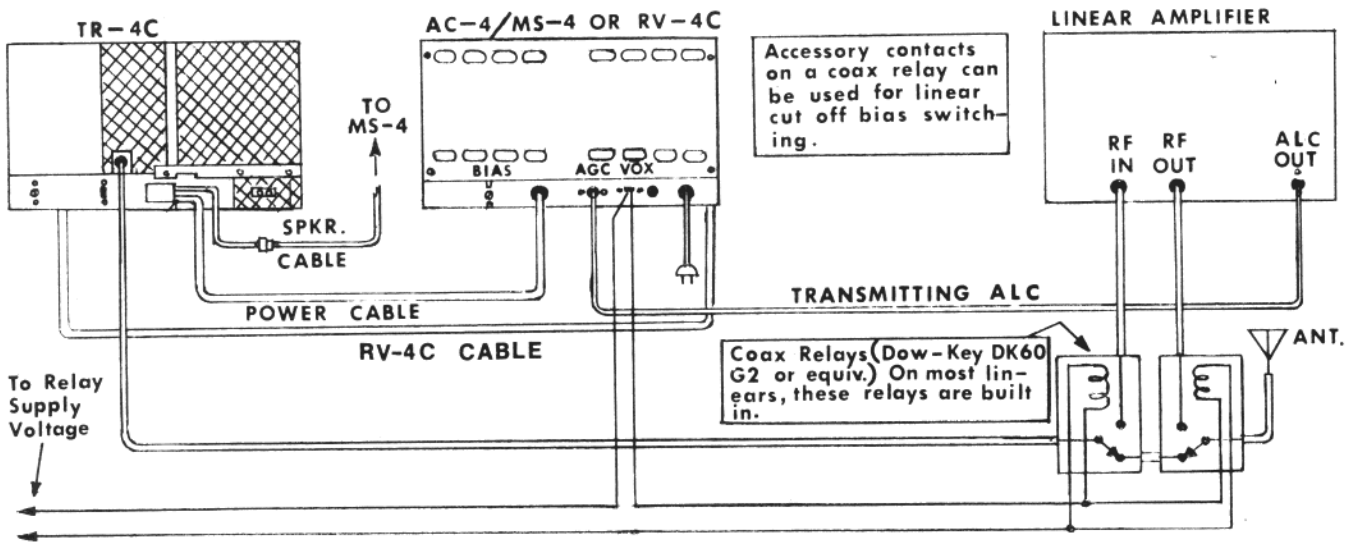

Figure 2-7. Connecting the AC-4 Power Supply, RV-4C Remote VFO and a Linear Amplifier

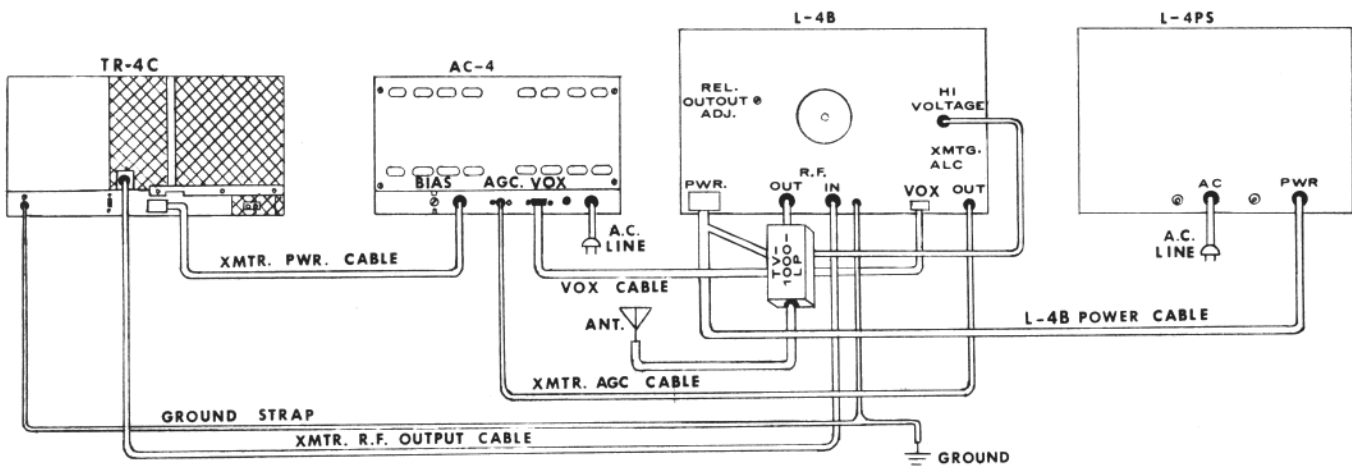

Figure 2-8. Connecting the AC-4 Power Supply and the L-4B Linear Amplifier

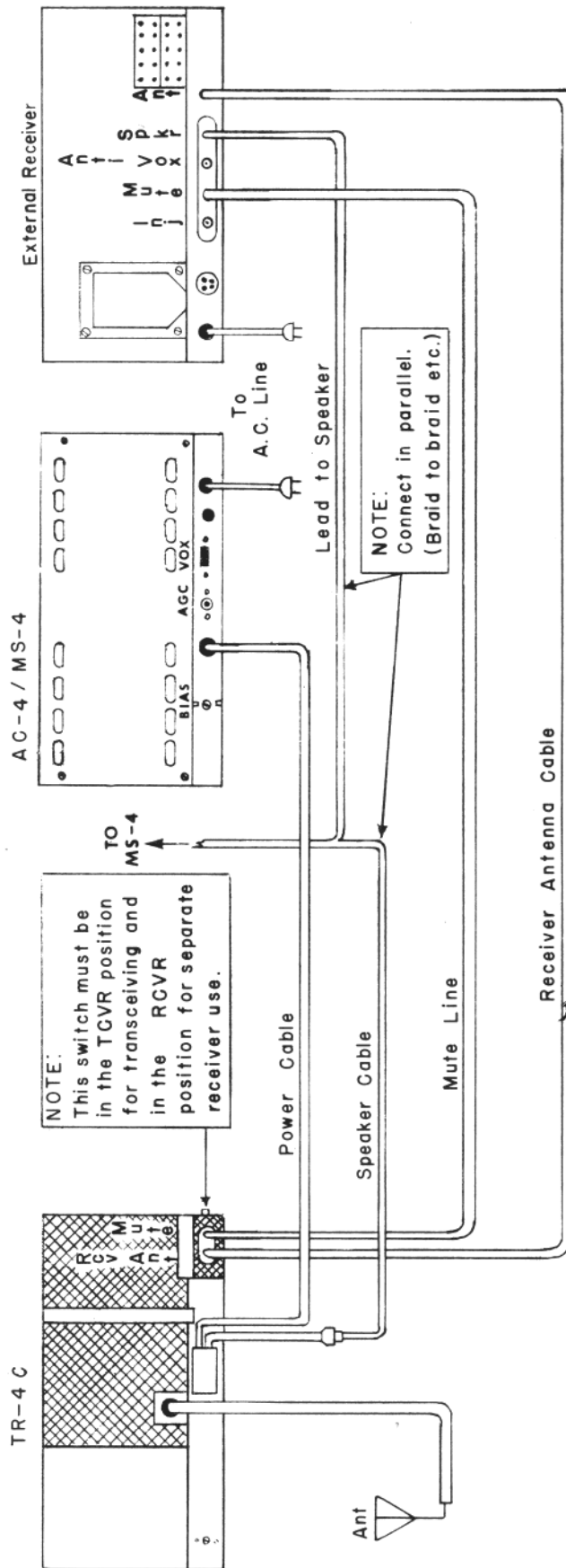

Figure 2-9. Connecting an External Receiver

CHAPTER III OPERATION

3-1. GENERAL.

Figure 3-1 illustrates and describes all front panel controls and indicators on the TR-4C Transceiver. Controls and connectors located on the rear and sides of the unit are described under "other controls" below. Rear chassis connectors are identified in figure 2-2.

3-2. MODE SWITCH. In the SSB position, the receiver portion functions until the transmitter is energized either by talking into the microphone or actuating the microphone push-to-talk switch. The transmitter then emits an upper or lower sideband signal depending on the setting of the **SIDEBAND** switch. In the X-CW position, the receiver portion functions until the key is closed. The TR-4C then goes into the transmit mode, a CW sidetone is energized and the carrier is shifted approximately 1 kHz from the received frequency. The unit will remain in transmit during CW keying and will return to receive when keying is stopped briefly. **NOTE:** The **SIDEBAND** switch must be in the X position when the Mode switch is on X-CW or X-AM. It should also be noted that if the relays fail to close occasionally when the key is used, advance the **VOX** gain (screwdriver adjust on the right side of the chassis) until positive relay action is obtained. In the X-AM position, a controlled carrier screen modulator is incorporated for AM transmission and a diode detector is used for AM reception. Transmit and receive switching is accomplished by **VOX** or push-to-talk as on SSB.

3-3. BLANKER SWITCH. The noise blanker may be left on except when there is a strong signal within 5 kHz of the received signal. A strong signal which falls within the 10 kHz wide crystal filter in the noise blanker, and outside the 2.1 kHz crystal filter in the TR-4C, will operate the noise blanker gate circuit causing distortion products. This limitation in the noise blanker is caused by the necessity of having a bandwidth in the blanker wide enough to minimize stretching of noise pulses before blank-

ing. Usually this limitation is no problem under normal operating conditions.

3-4. VFO DIAL. This dial consists of 2 transparent discs which display concentric scales and which rotate at different speeds. There are 2 scales on each disc. The upper scale on each disc is used for all bands except 20 meters where the lower scale is used. Zero to 100 kHz is indicated on one disc and hundreds of kHz is indicated on the other. The frequency of the operating signal is the sum of the frequencies indicated by the **BAND** switch and the VFO dial, for example:

BAND switch frequency	7.000 MHz
100 kHz dial	.200
1 kHz dial	.072
Operating frequency	<hr/> 7.272 MHz

This dial may be calibrated over a short range by the following procedure:

- Set the Mode switch to **CAL**.
- Tune the TR-4C to zero beat with the nearest 100 kHz calibrator signal.
- Hold the tuning knob stationary and rotate the knob skirt until the dial displays the correct frequency.

3-5. TUNING PROCEDURE.

CAUTION

Under no circumstances should operation of the TR-4C be attempted until it is connected to a proper antenna or a dummy load. Always allow a two minute warm up period after the TR-4C is turned on before transmitting.

3-6. BIAS ADJUSTMENT. Before any type of operation is attempted, it will be necessary to set the PA bias to the correct value. Proceed as follows:

- Turn on the TR-4C with the **RCVR GAIN** control.
- Rotate the **XMTR GAIN** control fully counter-clockwise.

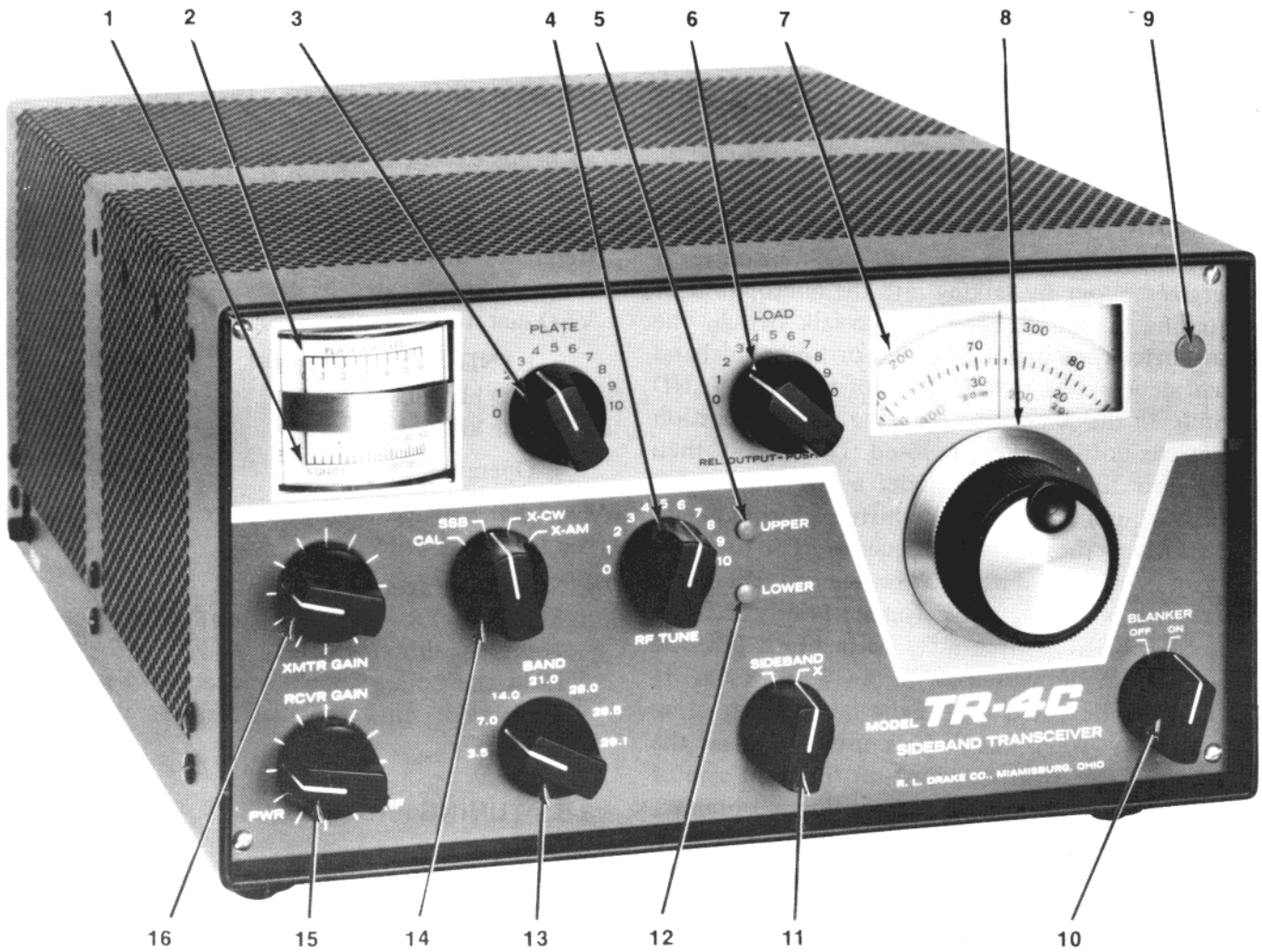

Figure 3-1. Front Panel Controls

FRONT PANEL CONTROLS

1. S meter: Indicates relative level of received signals. Indicates transmitter AGC when transmitting.
2. Plate meter: Indicates plate current in the final amplifier. Indicates relative RF power when LOAD control (6) is pushed in.
3. PLATE control: Tunes power amplifier pi-network circuit for resonance.
4. RF TUNE control: Peak tunes the receiver RF amplifier, the transmitter driver grid and plate tuned circuits.
5. UPPER sideband indicator lamp: Glows when upper sideband is selected.
6. LOAD control: Matches the TR-4C to the impedance of the antenna. Push in to display relative R F power on plate meter (2).
7. VFO dial: Displays portion of operating frequency from zero to 600 kHz. Reading must be added to BAND switch frequency setting for complete operating frequency.
8. VFO control: Adjusts frequency setting of dial (7).
9. VFO indicator lamp: Glows only when TR-4C VFO is operating.
10. BLANKER switch: Provides on/off control for R. L. Drake's Model 34-PNB Noise Blanker (an accessory).
11. SIDEBAND switch: Selects upper or lower sideband and lights appropriate indicator lamp (5 or 12).
12. LOWER sideband indicator lamp: Glows when lower sideband is selected.
13. BAND switch: Selects the desired amateur band.
14. Mode switch: Selects the desired mode of operation. In CAL position, it switches on the 100 kHz crystal calibrator (operable in transmit or receiver mode).
15. RCVR GAIN control: Dual control. Knob controls the receiver audio level, and provides a power on/off control at the extreme counter-clockwise position. Lever controls the maximum RF gain of the receiver.
16. XMTR GAIN control: Adjusts the microphone gain on AM and SSB. In CW mode it adjusts the RF drive.

OTHER CONTROLS

Right Side (not illustrated).

PHONE jack: Provides a connection for headphones or external speaker.

MIC jack: Provides a connection for microphone. Mates with connector S-230 furnished with the TR-4C.

VOX control: Adjusts the gain of the VOX amplifier and the antenna relay release time on cw.

ANTIVOX control: Adjusts the gain of the ANTIVOX amplifier.

ZERO control: Adjusts the no-signal display of the S meter to **S1**.

KEY jack: Provides a connection for CW key. With key connected, transmitter is disabled for all modes of operation and receiver is disabled for AM unless the key is closed.

Left Side (not illustrated).

RCVR/TCVR switch: Selects either the TR-4C Receiver or external receiver.

Rear Chassis (Refer to figure 2-2).

Ground terminal: Provides a connection for earth ground.

SIDE TONE control: Adjusts the level of the CW sidetone with respect to the received signal. For no sidetone, rotate fully counterclockwise.

LIGHTS switch: Changes intensity of dial lamps to dim (D) or bright (B).

Antenna connector: Provides a connection for the station antenna (SO-239).

Power connector: Provides a connection for either AC-4 or DC-4 Power Supply.

External Receiver Antenna jack: Provides a connection for an external receiver.

External Receiver Mute jack: Provides a connection for muting an external receiver. It may be used with any receiver which requires a DC path to ground for receiving and an open circuit for muting. All R. L. Drake receivers have this feature.

NOTE

Rear chassis markings **above** the CAUTION notice identify external cable connectors when TR-4C VHF Modification Kit is used.

- c. Turn the **SIDEBAND** switch to its counter-clockwise position.
- d. Turn the Mode switch to **X-CW**.
- e. Adjust the Power Supply (AC-4 or DC-4) bias control for a reading of 0.1 Amperes on the plate current meter.

3-7. **TUNE UP.** Do not allow plate current to exceed 0.1 Amperes for more than 6 seconds with the **PLATE** control not tuned for minimum plate current or maximum RF output.

CAUTION

Failure to observe the warning above will result in rapid final amplifier tube deterioration due to excessive plate dissipation.

The final amplifier pi-network will match a nominal 50 ohm lead. The **VSWR** may be as high as 2: 1 on all bands except 80 meters where a lower **VSWR** may be required. On 80 meters an external antenna matching network may be required.

Preset the controls as follows:

- a. Select the desired band with the **BAND** switch.
- b. Select the desired operating frequency with the VFO tuning knob.
- c. Rotate the **XMTR GAIN** control full counter-clockwise.
- d. Rotate the **LOAD** control full counterclockwise.
- e. Place the **SIDEBAND** control in the **X** position.
- f. Place the Mode switch in the **SSB** position.
- g. Peak the **RF TUNE** control for maximum noise or signal as indicated by the **S** meter.

Rotate the Mode switch to the **X-CW** position and advance the **XMTR GAIN** control until the plate current meter moves up scale slightly. Peak the **RF TUNE** control for maximum plate current and quickly tune the **PLATE** control for a dip in plate current. After the dip is found, rotate the **XMTR GAIN** control clockwise until plate current no longer increases.

Depress the **LOAD** control and alternately adjust the **PLATE** and **LOAD** controls in small increments for maximum RF output. Release the **LOAD** control and adjust the **PLATE** control for minimum plate current. At this point the plate meter should indicate a plate current between 0.380 and 0.500

Amperes. The reading will depend on the line voltage, antenna match, tube condition, etc. Increasing the setting of the **LOAD** control beyond the point at which maximum RF output occurs will result in excessive plate dissipation. It should not be necessary to advance the **LOAD** control beyond 4.5 to obtain maximum RF output. Further advancement indicates that the **VSWR** of the antenna system is too high and leaving the control set beyond this point is likely to result in excessive harmonic radiation. The above procedure should be completed as quickly as possible and the Mode switch should be returned to the **SSB** position.

When the Mode switch is in the **X-CW** position, the screen voltage on the final amplifier tubes is reduced to prevent overheating. When the switch is in the **SSB** position, this voltage is increased so that an input power of 300 watts can be obtained.

3-8. **SSB OPERATION.**

In the following discussion, it is assumed that the **TR-4C** has already been tuned up on the desired band as described in paragraph 3-7. Preset the controls as follows:

SIDEBAND	-On desired sideband as shown by indicator lights.
Mode	-On SSB .
XMTR GAIN	-Fully counterclockwise.
RF gain (lever)	-Fully clockwise.
RCVR GAIN (knob)	-Fully counterclockwise (do not turn off power).
VOX gain	-Fully clockwise.
ANTIVOX	-Fully counterclockwise.

While talking into the microphone in a normal voice, increase the **XMTR GAIN** control until the **S** meter starts kicking up scale above its resting value. With no modulation, the **S** meter will rest up scale on transmit. This indicates that the transmitter **AGC** is starting to operate and the transmitter has maximum output. Continue talking and reduce the **VOX gain** until a point is reached where further reduction results in a too frequent relay drop out. Increase the **AF GAIN** until received signals are of the desired level. This may cause the transceiver to cycle back and forth between transmit and receive. Adjust the **ANTIVOX** control until the cycling stops. If the push-to-talk switch on the microphone is properly connected as described under Installa-

tion, it may be depressed at any time, thus overriding the VOX system. If VOX operation is not desired, turn the VOX gain control fully counterclockwise.

On SSB, the TR-4C transmits on exactly the same frequency on which it receives. Therefore, be sure that you have the signals tuned in so that the voices sound normal before you answer another station's CQ, or break another QSO. Otherwise, you will not be transmitting exactly on frequency. If a key is used, it must either be closed or unplugged from the KEY jack for SSB and AM operation.

3-9. CW OPERATION.

To operate CW, connect a key to the KEY jack. If an electronic keyer is used, connect it for grid block keying. Leave the key in the open condition. The TR-4C uses shifted carrier CW. With this system, it is possible to transmit approximately on the received station's frequency without being zero beat while receiving. The transmitter BFO is shifted from the received signal frequency by approximately 1 kHz. The VFO dial reads the correct frequency of a received signal when the signal is tuned for zero beat.

To receive CW signals, place the Mode switch in the X-CW position and the SIDEBAND switch in the X position. Tune in a CW signal for an audio pitch of about 1 kHz and adjust the audio gain control knob for a normal listening level.

To transmit, depress the key, and adjust the XMTR GAIN control until it is just below the point at which plate current no longer increases. Do not advance it beyond this point. Advance the SIDETONE control on the rear of the chassis until the sidetone reaches the desired volume. Adjusting the RCVR GAIN knob controls both the received signal and sidetone level.

The TR-4C uses automatic transmit/receive switching. This means that it will automatically transmit when the key is depressed and will remain in the transmit condition during keying. It will return to the receive condition when the key is released for a brief period. If this period is too long, decrease the VOX gain. Manual transmit/receive switching can

be accomplished by connecting an external switch to the push-to-talk circuit of the MIC jack.

3-10. AM OPERATION.

For AM operation, the Mode switch should be in the X-AM position and the SIDEBAND switch should be in the X position. If a key is used, it should be left closed or unplugged. Tune in AM signals for most pleasing audio. This will not necessarily coincide with maximum S meter reading. The same procedure should be followed in setting the various gain controls on AM as on SSB, except that the XMTR GAIN control should be adjusted for plate current peaks of 0.2 to 0.25 Amperes when talking into the microphone in a normal voice. Care should be taken to stay within these limits since the transmitter AGC does not operate on AM.

3-11. OPERATION NEAR BAND EDGES.

When operating near the edge of a band, be sure to check the dial calibration as described under tuning procedure. When working SSB be sure to use the sideband that will be inside the band. On AM and CW, the transmitted carrier will be 1 kHz higher or lower than the indicated dial frequency.

3-12. OPERATION WITH A LINEAR AMPLIFIER.

Since the TR-4C Transceiver is conservatively rated at 300 watts PEP input, it is doubtful if it would be worthwhile to use a linear amplifier with a power rating of less than 1000 to 2000 watts PEP input. A triode type grounded grid linear amplifier with a 1000 to 2000 watt PEP rating will present a satisfactory load to the TR-4C.

If the linear amplifier is of the grounded cathode type with high impedance input, it will be necessary to install a resistive pad between the TR-4C and the linear amplifier that will present the proper impedance to the TR-4C. Such a pad must be made of non-inductive resistors and must have adequate power handling capacity. Antenna switching should be accomplished as shown in figure 2-7. Most linear amplifiers have these relays built-in.

To properly operate the TR-4C with a linear amplifier proceed as follows:

- a. With the TR-4C connected to the linear amplifier tune the RF TUNE control as described in paragraph 3-7 g.
- b. Set the LOAD control to the setting indicated on the chart below, for the band desired, when using a linear amplifier with a 50 ohm input.

BAND	50 Ohm LOAD Setting
3.5 MHz	2
7.0 MHz	3
14.0 MHz	2
21.0 MHz	3
28.5 MHz	2

- c. Tune the PLATE control for minimum plate current.
- d. Switch the Mode switch to the desired mode of operation.
- e. Advance the XMTR GAIN control until the desired amount of input to the linear amplifier is obtained.

Note that when the TR-4C is loaded much below maximum RF output the AGC does not function properly and flat topping in the TR-4C may result. Care should be taken to keep the XMTR GAIN below the point where this occurs. This can be accomplished by making sure that the average peak plate current does not exceed one half of the plate current obtained on tune up.

If your linear amplifier has AGC output, connect it to the TR-4C as shown in figure 2-7. If the TR-4C is properly tuned, this should prevent flat

topping on SSB regardless of the XMTR GAIN control setting. However, it will not prevent overdrive on AM since the AGC does not function in this mode.

3-13. NOVICE OPERATION.

If used on the novice bands with crystal control or VFO control, maximum legal input power is 75 Watts which occurs when the Plate Meter reads 0.15 Ampere. To realize the most useful output under these conditions, readjustment of the Bias control on the Power Supply is suggested. Follow the Bias Adjustment procedure in paragraph 3-6, except set bias control on AC-4 for minimum readable plate current. If the transceiver is used on both novice band and by another operator on SSB or AM, the bias must be readjusted to its former value before such operation is attempted.

To load the transmitter for novice operation, preset controls as described in paragraph 3-6. Turn the MODE switch to X-CW and advance XMTR GAIN for a very slight increase in plate current. Tune RF TUNE for a peak in plate current, being careful not to exceed 0.115 Ampere, and quickly tune PLATE control for a dip in plate current. Turn XMTR GAIN control fully clockwise and adjust LOAD control until plate dip occurs at 0.15 Ampere. If plate current dip is higher than this when LOAD control is set to 0, reduce the XMTR GAIN for plate reading of 0.115 Ampere. Turn MODE switch to X-CW and set GAIN control for a plate current of 0.15 Ampere.

CHAPTER IV

THEORY OF OPERATION

4-1. GENERAL.

The **TR-4C** is a 300 Watt HF single sideband transceiver which covers the 80 through 10 meter amateur bands. **AM** and **CW** modes are also included. The **TR-4C** requires either an R. L. Drake AC-4, **120 V AC** power supply, or an R. L. Drake DC-4, **12 V DC** power supply. The TR-4C features a high-stability linear permeability tuned VFO and two 8 pole crystal lattice filters for sideband selection. Some of the circuits are common to both the transmit and receive functions. Refer to the block diagram figure 4-1 and the schematic diagram figure 5-5 as required to supplement the following discussion.

4-2. RECEIVER CIRCUITRY.

A signal entering the antenna terminal passes through the antenna switching contacts of the relay and is applied to the grid of the RF amplifier V7 through the selectivity of the L/C network formed by T9, T 10 and a section of the RF TUNE capacitor C37. After being amplified, it is passed through an additional L/C network consisting of T7, T8 and the remaining section of C37, to the grid of the mixer V3B. At this point it is combined with a signal from the pre-mixer system of the required frequency to yield a 9.0 MHz IF. The pre-mixer system consists of a 4.9-5.5 MHz solid state permeability tuned VFO, a buffer Q2, a switchable overtone crystal oscillator V1 A, the pre-mixer pentode V1 B and a cathode follower V3A.

The VFO signal output is applied to the grid of the pre-mixer pentode through the buffer Q2 and its associated circuitry. For 80 and 20 meter operation, the VFO signal bypasses the pre-mixer and is connected through the cathode follower to the mixer. On 40, 15 and 10 meters a signal from the crystal oscillator heterodynes with the VFO in the pre-mixer, V1 B, to produce the desired injection frequency. On 40 meters, for example, a 21.5 MHz overtone crystal and the appropriate coil L1 are switched into the crystal oscillator circuit. The

output from the oscillator is coupled into the pre-mixer pentode where it heterodynes with the 4.9-5.5 MHz VFO to produce an output frequency of 16.0-16.6 MHz. This output is coupled through the 16.0-16.6 MHz bandpass coupler, T3, and to the cathode follower, V3A. On 15 meters, a 35.5 MHz crystal is used with a 30.0-30.6 MHz coupler, T2, and on the three **10** meter ranges, 42.5, 43.0 and 43.6 MHz crystals are used with a 37.0-38.7 MHz coupler, T1 .

The 9.0 MHz output of the mixer, V3B, passes through the impedance matching transformer T6 into the upper or lower sideband crystal filter. The setting of the **SIDEBAND** knob determines which crystal filter is used. From the crystal filter the signal passes through the impedance matching transformer, T13, and is amplified by the 9 MHz receiver IF amplifier system, V 11 and V 12 and the IF transformers T1 1 and T12. The output of T12 is applied to the AGC amplifier, V13A, to the product detector, V16, and to the diode detector, V2.

The AGC amplifier V1 3A is biased beyond cutoff to provide an AGC delay. When sufficient RF voltage from T12 is applied to its grid, plate current flows during part of the cycle. This causes amplified negative voltage to appear across its plate load resistor R63, thus charging C1 15. This negative control voltage is applied to the grids of V7, V1 1 and V12. C1 15 discharges through R63 with a time constant of approximately one second. Rotating the RF Gain control counterclockwise applies increasingly more negative bias to the AGC controlled grids, thus limiting their maximum gain.

The product detector tube, V16, consists of a 9 MHz crystal oscillator formed by the cathode, grid 1 and grid 2. A product detector is formed by the cathode, grid 3, and the plate. The IF signal is applied to grid 3 where it heterodynes with the BFO voltage in the tube. The resulting audio signal is of sufficient amplitude to drive the audio pre-amplifier transistor, Q5, which drives the audio output tube, V17.

The IF signal from T12 is also applied to V2 which functions as a diode detector and an audio amplifier in the AM receive mode. The output of this stage is also fed to the Mode switch and is connected to V17 through the Audio Gain control when the Mode switch is in the X-AM position. The output of V17 is applied through the audio output transformer to the phone jack, J5, and to pin 12 of the power connector. Also, output from the plate of V17 is applied to the anti vox rectifier, D6, through the ANTIVOX control.

A 100 kHz crystal calibrator, V5, is switched on when the Mode switch is in the CAL position. Its output is coupled to the grid of the RF amplifier V7.

The S meter in the TR-4C operates in a bridge circuit with the plates of a receiver IF amplifier, V11, and the transmitter IF amplifier, V15 in one leg of the bridge and plate of the audio output tube V17 in the other leg. Receiver AGC voltage applied to V11 on receive and transmit causes these tubes to draw less current, thus unbalancing the bridge, which causes the S meter to read up scale. The bridge is balanced on receive by the ZERO control. On transmit, the meter may rest up scale with no modulation.

4-3. TRANSMITTER CIRCUITRY.

Audio input from the microphone is applied to one section of the microphone amplifier V18 where it is amplified and applied to the remaining section of this tube through one section of the XMTR GAIN control. Output from the cathode of the second triode of V18 is applied to the balanced modulator through the Mode switch for SSB operation. Output from the plate is applied to the grid of the AM screen modulator, V14, and to the grid of the first VOX amplifier triode, V19A, through the VOX control. The output from V19A is rectified by the VOX rectifier, D5, and the resulting positive DC voltage is applied to the grid of the relay control triode, V19B, causing it to conduct and to close the transmit/receive relay.

Audio voltage from V17 is rectified by the anti vox rectifier, D6, which supplies negative voltage to the grid of V19B, and preventing it from conducting

and closing the relay when the microphone picks up audio from the speaker.

Cut off bias for the relay tube is obtained from a voltage divider. When the microphone push-to-talk switch is activated the cut off bias is grounded, causing VI 9B to conduct and close the relay.

RF from the 9.0 MHz crystal oscillator portion of the product detector tube V16 is applied to the balanced diode modulator through the carrier balance control. On SSB the audio from V18 is also applied to the balanced modulator and the result is a double sideband suppressed carrier signal which is applied to the transmitter IF amplifier. The amplified output is coupled through T13 to the upper or lower crystal filter where the undesired sideband is filtered out. The resulting SSB signal is coupled through T6 to the transmitter mixer, V4, where it is combined with a pre-mixer signal of the proper frequency to give output on the desired amateur band.

Output from V4 passes through the L/C circuit, T7, T8 and C37, and is applied to the grid of the driver tube, V6. Here it is amplified and applied to the grids of V8, V9, and V10 through the L/C network, T9, T10 and the other half of C37.

Three parallel power amplifier tubes boost the signal to a power level suitable for transmission. The output impedance of the power amplifier tubes is matched to a 52 ohm load by means of the pi network circuit composed of L8, L9, C94 and C95.

At the first trace of flat topping in the final amplifier tubes, a small amount of grid current will be drawn. This produces a voltage drop across R47. The small negative going voltage thus obtained is applied through R46 to the cathode of V13B where it is amplified. The amplified negative voltage is applied to the grid of V15, thus reducing the level of the driving signal.

When the Mode switch is placed in the X-CW position, V2 becomes an audio phase shift oscillator which is grid-block keyed along with the transmitter mixer, V4, and the driver, V6. The audio output from V2 is applied to the grid of the

product detector tube V16, through the SIDETONE control, to provide audio output from the speaker for CW monitoring. Audio output from V2 is also applied to the grid of the VOX amplifier tube, V19A, which causes relays K1 and K2 to close. The relays turn on the transmitter, cause the 9.0 MHz oscillator to be shifted to 9.001 MHz and apply a variable source of DC, controlled by half of the XMTR GAIN control, to the balanced modulator. The DC voltage which unbalances the modulator increases the carrier to a suitable level. The resulting 9.001 MHz signal from the balanced modulator is amplified by V15 and coupled into the crystal filter. The SIDEBAND control must be in the "X" position to allow the signal to pass. A screen resistor is switched into the final amplifier screen circuit to prevent excessive screen current in the X-CW position of the Mode switch.

When the Mode switch is placed in the X-AM position the AM screen modulator V14 is inserted in series with the final amplifier screen supply and a constant voltage is applied to the balanced modula-

tor. Relay K2 shifts the 9 MHz oscillator to 9.001 on transmit just as it does on X-CW. Vox and PTT functions are the same on AM as on SSB.

When relay K1 is closed, either by the VOX circuit or the push-to-talk switch, the cathode of V3B, V7, V11 and V12 are isolated from ground which disables the receiver. The cathodes of V4, V6, V8, V9, V10 and V15 are connected to ground which actuates the transmitter. Also, the antenna is switched from the receiver input to the final amplifier tank circuit. If the TCVR/RCVR switch is in the RCVR position, the RCVR MUTE jack is grounded through RFC 11 and RFC 7 and the antenna is connected to the RCVR ANT jack instead of T9 in the receive condition of the relays.

Pushing in the LOAD control disconnects the plate current meter from the final amplifier cathode circuit and connects it to the diode D9 and its associated circuitry. This network samples the RF output voltage at the antenna connection, rectifies it, and applies it across the meter.

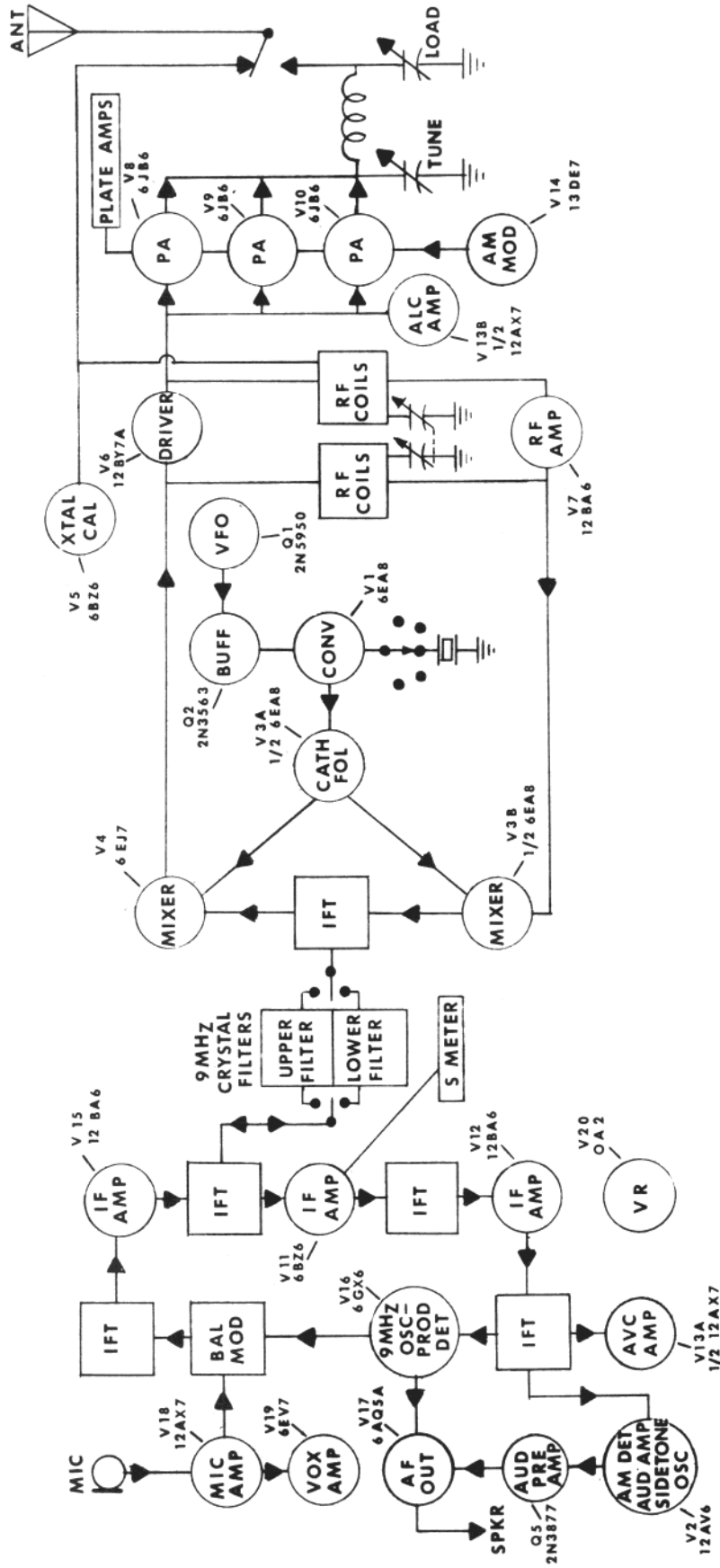

Figure 4-1. Block Diagram

CHAPTER V

MAINTENANCE

5-1. SERVICE DATA.

We will check and align your transceiver at the factory for a nominal fee if it has not been tampered with. Transportation charges are extra. Any necessary repairs will be made on a time and material basis. Please write or call the factory for authorization before returning your unit for alignment or service. Address your request for authorization to:

R. L. Drake Company
540 Richard Street
Miamisburg, Ohio 45342
ATTN: Customer Service Department
Telephone (Area Code 513) 866-3211
(Code-A-Phone Service after
1630 Hours E.S.T.)

WARNING

Extreme caution should be exercised when the top and bottom covers are removed. High voltage which is present at several points can cause a lethal electrical shock. Repairs and adjustments should be made only by a qualified electronics technician. Disconnect the Power Supply from the TR-4C before removing covers.

5-2. TOP COVER REMOVAL.

Remove the three top screws on each side of the TR-4C and remove the cover by first pulling up on the rear and then the front of the cabinet.

5-3. BOTTOM COVER REMOVAL.

Remove the three bottom screws on each side of the TR-4C and lift the chassis out of the bottom cover.

5-4. TUBE REPLACEMENT.

In general, most trouble in electronic equipment of good design is due to tube failure. The best method of finding defective tubes is by direct substitution. It is best not to rely too heavily on tube checkers. The TR-4C has been designed so that, with the exception of V8, V9 and **V10**, tubes can be replaced without need for realignment. These tubes are to be replaced with a matched set of the same brand as originally supplied. If a different brand is used, alignment of T7, T8, T9 and final amplifier neutralization is recommended. Matched sets of Sylvania 6JB6's are available directly from the factory. To replace the 6JB6 tubes, it is necessary to remove only the top of the final amplifier cage. To do this, remove the sheet metal screws holding the PA cover to the cage. A disc-handle is provided on the cover to facilitate removal. To replace the PA cover, simply reverse the process. Be sure the parasitic suppressors do not short to the cage.

5-5. TROUBLE SHOOTING.

Careful consideration has been given in the design of the TR-4C to keep maintenance problems to a minimum. However, it is quite possible that some problem will arise which cannot be cured by tube substitution. If this occurs, it is suggested that the TR-4C be returned to the dealer or you may write to the Customer Service Department at the address given in paragraph 5-1. Be sure to describe the problem in detail. Include full information concerning external connections, control settings, tubes substituted, serial number, etc. Always include the serial number when requesting service information. Before returning equipment to the factory, it is necessary to get prior authorization. In case of malfunction, first check the power supply fuse, the filament fuse in the TR-4C and the number 12 fuse lamp near the relay assembly for continuity. The voltage and resistance charts in this chapter should be valuable in isolating minor problems.

However, no attempt should be made to service the TR-4C unless you are thoroughly familiar with electronic circuitry and servicing technique. Care should be taken not to disturb the lead dress in the TR-4C since several circuits are quite critical in this regard.

5-6. TEST EQUIPMENT.

Alignment of TR-4C will require the following equipment:

- a. A general coverage receiver capable of receiving WWV.
- b. An 11 Megohm VTVM.
- c. An alignment load consisting of a 1000 Ohm non-inductive resistor in series with a .005 uF disc ceramic capacitor.
- d. A 52 Ohm dummy load.

WARNING

Before receiver alignment is attempted, the plate and screen power leads of the amplifier tubes should be disconnected where they pass through the partition under the chassis. Be sure the power is disconnected before this is attempted, or serious electrical shock may result.

5-7. ALIGNMENT PROCEDURES.

5-8. CRYSTAL CALIBRATOR. To align the crystal calibrator perform the following steps:

- a. Let the TR-4C warm up for 30 minutes.
- b. Preset the XMTR GAIN control fully counter-clockwise.
- c. Set the Mode switch to CAL.
- d. Tune in WWV on the general coverage receiver with the BFO off.
- e. Connect a wire from the receiver antenna terminal to V5 of the TR-4C. Wrap the wire around the tube a turn or two.
- f. Adjust C45, located on top of the TR-4C chassis, until the calibrator signal is zero beat with the unmodulated WWV carrier.

5-9. 9.0 MHz OSCILLATOR.

- a. Let the TR-4C warm up for 30 minutes.
- b. Set the Mode switch in the SSB position.

- c. Turn up the Audio Gain control until noise is audible in the speaker.
- d. While switching the SIDEBAND knob back and forth, adjust C1 30, located on top of the chassis near the rear edge, until the pitch of the noise is the same on both positions.

5-10. INJECTION CRYSTAL OSCILLATOR.

- a. Set the VTVM to its lowest DC negative volt scale and set the pointer to about center scale with VTVM zero adjust control.
- b. Connect the common lead of the VTVM to the TR-4C chassis and the DC lead to the test point which is connected to pin 9 of V1.
- c. Set BAND switch to 7.0 MHz and adjust L1 for maximum negative DC voltage.
- d. Switch to 21.0 MHz and adjust L5 for maximum as in Step c.
- e. Switch to 29.1 MHz and adjust L2 for maximum as in Step c.
- f. The 28.0, the 28.5 and the 29.1 MHz positions should have about the same negative voltage.

5-11. VFO ADJUSTMENT.

The permeability tuned VFO was carefully adjusted at the factory and should require no further alignment. If it does not appear to track from one end of its range to the other, it should be returned to the factory for realignment. Maximum calibration error is 1 kHz when calibrated to the nearest 100 kHz point.

5-12. INJECTION COUPLER.

- a. Tune in a crystal calibrator signal at 7.3 MHz.
- b. Connect the alignment load between pin 6 of V1 B and ground and adjust T3 (top) for maximum S meter reading.
- c. Connect the load from pin 9 of V3A and ground and adjust T3 (bottom) for maximum S meter reading.
- d. Tune in a crystal calibrator signal at 21.300 MHz and repeat the procedure for T2.
- e. Tune in a crystal calibrator signal at 29.000 MHz and repeat the above procedure for T1. *Note:* On T1, adjust the bottom slug when the load is on pin 6 of V1 B and the top slug when the load is on pin 9 on V3A.

Table 5-1. Resistance Chart

REF DES	Tube Type	MEASURED AT PIN								
		1	2	3	4	5	6	7	8	9
V1	6EA8	9.5 K	2.5 Meg	20 K	0	Fil	9.6 K	220	220	150 K
V2	12AV6	3.3 Meg	Inf.	Fil	0	150 K	150 K	350 K	—	—
v3	6EA8	8.0 K	150 K	250 K	Fil	0	11 K	2.2 K	1 K	34 K
v4	6EJ7	25 K	660 K	23 K	Fil	0	0	11 K	9.5 K	0
v5	6BZ6	1 Meg	1 K	Fil	0	350 K	125 K	1 K	—	—
V6	12BY7A	25 K	67 K	0	0	0	Fil	8.5 K	25 K	0
v7	12BA6	2.8 Meg	0	Fil	0	11 K	10K	100	—	—
V8	6JB6	8.2 K	40 K	23 K	Fil	Fil	40 K	8.2 K	0	23 K
v9	6JB6	8.2 K	40 K	23 K	Fil	Fil	40 K	8.2 K	0	23 K
V10	6JB6	8.2 K	40 K	23 K	Fil	Fil	40 K	8.2 K	0	23 K
V11	6BZ6	2.5 Meg	150	0	Fil	10K	13K	0	—	—
v12	12BA6	2.5 Meg	0	Fil	0	10K	13K	68	—	—
v13	12AX7	1 Meg	22 K	45 K	0	0	2.2 Meg	55K.	48K	Fil
v14	13DE7	8 K	2.5 Meg	2.5 Meg	Fil	0	2.2 Meg	22 Meg	0	Inf.
v15	12BA6	2 Meg	0	0	Fil	10 K	13 K	25 K	—	—
V16	6GX6	2.2 Meg	1 K	0	Fil	250 K	9.2 K	22 K	—	-
v17	6AQ5	500 K	270	0	Fil	8.7 K	8 K	500 K	—	—
V18	12AX7	350 K	6.8 Meg	0	0	Fil	350 K	500 K	3.3 K	N. C.
v19	6EV7	13 K	4.5 Meg	0	Fil	0	110K	450 K	820	1.5 Meg
v20	OA2	7.8 K	0	Inf.	0	7.8 K	Inf.	0	—	—

REF DES	Transistor Type	MEASURED AT:		
		Emitter	Base	Collector
Q1	2N5950	Located in PTO		
Q2	2N3563	Located in PTO		
Q3	AT5059	0	5.6 K	43 K
Q4	2N3394	0	750	1.1 K
Q5	2N3877	1 K	56 K	6.8 K

NOTE:

All measurements were made with respect to ground with the power supply disconnected from the TR-4C. The BAND switch was on 7.0 MHz, the Mode switch was on CAL and the RCVR GAIN and XMTR GAIN controls were fully clockwise. The VOX, ANTI VOX and SIDETONE controls were fully clockwise and the ZERO control was set at the balance point. The accessory 34-PNB jumper plug was in the noise blanker jack.

Table 5-2. Voltage Chart

REF DES	Tube Type	MEASURED AT PIN								
		1	2	3	4	5	6	7	8	9
V1	6EA8	122	-2	125	0	6.3*	250 245	2.6	2.6	-1.3
V2	12AV6	0 -1.6	13.0 0	12.6*	0	0 0.9	0 0.9	255 122	—	—
V3	6EA8	155 150	0	98 150	6.3*	0	260 250	3.5 150	17 15.5	17 15.2
V4	6EJ7	155 2.8	0	NC	6.3*	0	0	270 230	175 145	—
V5	6BZ6	-42 0	0.9 23	12.6*	6.3*	70 140	58 144	0.9 23	—	—
V6	12BY7A	155 3.3	0	NC	0	0	6.3*	265 240	262 165	0
V7	12BA6	-1.4	0	12.6*	0	235 230	98 110	1.25 150	—	—
V8	6JB6	262 250	-60	155 1.0	6.3*	12.6*	-60	262 250	0	155 0.4
V9	6JB6	262 250	-60	155 1.0	6.3*	12.6*	-60	262 250	0	155 0.4
V10	6JB6	262 250	-60	155 1.0	6.3*	12.6*	-60	262 250	0	155 0.4
V11	6BZ6	-1.6	1.6 150	0	6.3*	235	125 150	0	—	—
V12	12BA6	-1.6	0	12.6*	0	240	105 150	1.1 150	—	—
V13	12AX7	-1 0	-61 -61	-59 -59	0	0	-1.6	-61 -61	-59 -58	6.3*
V14	13DE7	260 250	11.4 11.2	11.4 11.2	12.6*	0	11.4 11.2	-1.0 -1.0	0	64 53
V15	12BA6	0	0	0	12.6*	248 140	155 144	155 1.3	—	—
V16	6GX6	-6.0 -5.6	4.0	0	6.3*	140 140	140	0	—	—
V17	6AQ5	0	7.2 6.8	0	6.3*	240 230	155 150	NC	—	—
V18	12AX7	88 87	-0.75	0	0	12.6*	130 125	0	1.23 1.1	NC
V19	6EV7	260 180	-6 -3.6	0	6.3*	0	103 110	0	1.25 1.20	TP
V20	OA2	146	NC	NC	NC	NC	NC	0	—	—

Table 5-2. Voltage Chart (continued)

REF DES	Transistor Type	MEASURED AT:		
		Emitter	Base	Collector
Q1	2N5950	Located in PTO		
Q2	2N3563	Located in PTO		
Q3	AT5059	0	0	61
Q4	2N3394	0	11.2	0
Q5	2N3877	2.3	2.8	48

NOTE:

All measurements were made with an 11 Megohm VTVM and were taken from ground. RF TUNE, PLATE and LOAD controls were set as described in paragraph 3-7. BAND switch was on 7.0 MHz, VFO dial was at 7.250 MHz and SIDEBAND was on X. Receive measurements were made with the Mode switch in the CAL position and the transmit measurements were made with the Mode switch in the X-CW position, with the following exception :

On V14, both receive and transmit measurements were made with the Mode switch in the X-AM position and with PTT line grounded.

The AC-4 Power Supply was used. Where two voltages are shown, the top is for receive and the bottom is for transmit. An "*" indicates AC voltage. The accessory 34-PNB jumper plug was in the noise blanker jack.

5-13. RECEIVER IF.

- a. Peak the RF TUNE control on noise at 3.8 MHz.
- b. Adjust T11 top and bottom and T12 top and bottom for maximum noise from the speaker.

5-14. BALANCED MODULATOR AND CARRIER BALANCE.

- a. Disconnect the power supply and reconnect the screen and plate supply leads to the final amplifier tubes.
- b. Reconnect power supply.
- c. Connect dummy load to the antenna jack.
- d. Peak the RF TUNE control for maximum

receiver gain.

- e. Adjust bias per paragraph 3-6. With XMIT GAIN fully counterclockwise, place the Mode switch in X-CW position and SIDEBAND switch in X position.
- f. If the plate current exceeds 0.15 Ampere, adjust the RF TUNE for 0.15 Ampere maximum.
- g. If plate current is less than 0.15 Amperes, adjust Carrier Balance pot until plate current reaches 0.15 Amperes.
- h. Peak T14 for maximum plate current. Detune the RF TUNE control to prevent plate current from exceeding 0.15 Amperes.
- i. Alternately adjust the Carrier Balance control and C1 27 for minimum plate current. There should be no difference in plate current between the two positions of the SIDEBAND switch.

5-15. FILTER MATCHING TRANSFORMER.

- Adjust the S meter ZERO pot for zero S meter deflection (S-1).
- With the SIDEBAND switch in USB, tune in the calibrator signal at 3.8 MHz for maximum S meter reading.
- Adjust the RF TUNE control until the S meter reads S-9.
- Turn the VFO control clockwise to increase the audio frequency until the S meter drops to S-5.
- Adjust T6 and T13 for maximum S meter reading.
- Repeat Steps b. through e.
- Center the 9.0 MHz oscillator as described in paragraph 5-9.

3-16. MIXER AND RF ALIGNMENT.

- Tune up the TR-4C at 3.8 MHz for maximum power output into a dummy load. Set the RF TUNE control on 5. Adjust the XMTR GAIN control for 0.2 Amperes plate current as indicated by the plate meter. Adjust T7 bottom and T9 bottom for maximum plate current.
- Tune up the TR-4C at 7.3 MHz and repeat a. above, with the RF TUNE control on 6, by adjusting T8 top and T10 top.
- Set RF TUNE control on 5. Tune up the TR-4C at 14.3 MHz and repeat a. above by adjusting T7 top and T9 top.
- Tune up the TR-4C at 29.7 MHz (crystal not supplied). With the RF TUNE control at 9% repeat a. above by adjusting T8 bottom and T10 bottom.
- Set RF TUNE control on 5. Tune up the TR-4C at 21.3 MHz and repeat a. above by adjusting L6 and L7.

5-17. PA NEUTRALIZATION.

- Attach an RF output indicator between the TR-4C and the dummy load. If no external output indicator is available, the TR-4C's own RF output indicator may be used.
- Tune up the TR-4C on 29.0 MHz for maximum power output into a dummy load.
- Reduce plate current to 0.2 Amperes with the XMTR GAIN control.
- While tuning the PLATE control back and forth through resonance, adjust C76, using an insulated screwdriver, until the plate current dip and maximum RF output occur simultaneously. An insulated screwdriver is required because the rotor of C76 is connected to + 250 Volts DC.

5-18. TRANSMITTER IF NEUTRALIZATION.

- With microphone plugged into TR-4C, turn the VOX gain fully counterclockwise and turn XMTR GAIN fully clockwise. Place the Mode switch in the SSB position.
- While talking into the microphone, increase the RCVR GAIN control setting until speech can be heard from the speaker.
- Adjust C168 for minimum output from speaker.
- If over one turn of adjustment is required, it will be necessary to realign T14, C 127 and the Carrier Balance control.

5-19. S METER ADJUSTMENT.

With the RF GAIN control fully counterclockwise adjust R187 for an S meter reading of 60 dB over s-9.

Table 5-3. Tube and Semiconductor Complement

REF DES	Component Type	FUNCTION	
		Transmitter	Receiver
V1	6EA8	Pre-Mixer/Xtal Oscillator	Pre-Mixer/&al Oscillator
v 2	12AV6	Sidetone Oscillator	Diode Det/1 st AF Amplifier
v 3	6EA8	Cathode Fol.	Mixer/Cathode Fol.
v 4	6EJ7	Mixer	—
v 5	6BZ6	—	Crystal Calibrator
V6	12BY7	Driver	—
v7	12BA6	—	RF Amplifier

Table 5-3. (Con tinued)

REF DES	Component Type	FUNCTION	
		Transmitter	Receiver
V8, V9, V10	(3) 6JB6 Matched	Power Amps.	
V11	6BZ6	—	IF Amplifier
v12	12BA6	—	IF Amplifier
v13	12AX7	AGC	AGC
v14	13DE7	AM Screen Modulator	—
v15	12BA6	IF Amplifier	—
V16	6GX6	9 MHz Xtal Oscillator	BFO/Product Detector
v17	6AQ5A	Anti Vox	Audio Output
V18	12AX7	Mike Amplifier	—
v19	6EV7	VoxAmp/Relay	
v20	OA2	Voltage Regulator	Voltage Regulator
Q1	2N5950	VFO	VFO
Q2	2N3563	VFO Buffer	VFO Buffer
Q3	AT5059	Neon Driver	Neon Driver
Q4	2N3394	VFO Shut tiff	VFO Shut Off
Q5	2N3877		Audio Pre-Amp
D1	1N541	Balanced Modulator	—
D2	1N541	Balanced Modulator	
D3	1N541	Balanced Modulator	
D4	1N541	Balanced Modulator	—
D5	1N4148	Vox Detector	
D6	1N4148	Anti Vox Detector	
D7	1N4148	Vox Relay Speed Up	—
D8	1N714	Voltage Regulator	Voltage Regulator
D9	1N4148	Output Power Detector	
D10	1N4148	Anti Vox Detector	
D11	1N4148	Output Power Detector	
D12		Meter Control	—
D13	1N4148	Transient Suppressor	Transient Suppressor
D14	1N4148	AGC Isolation	—

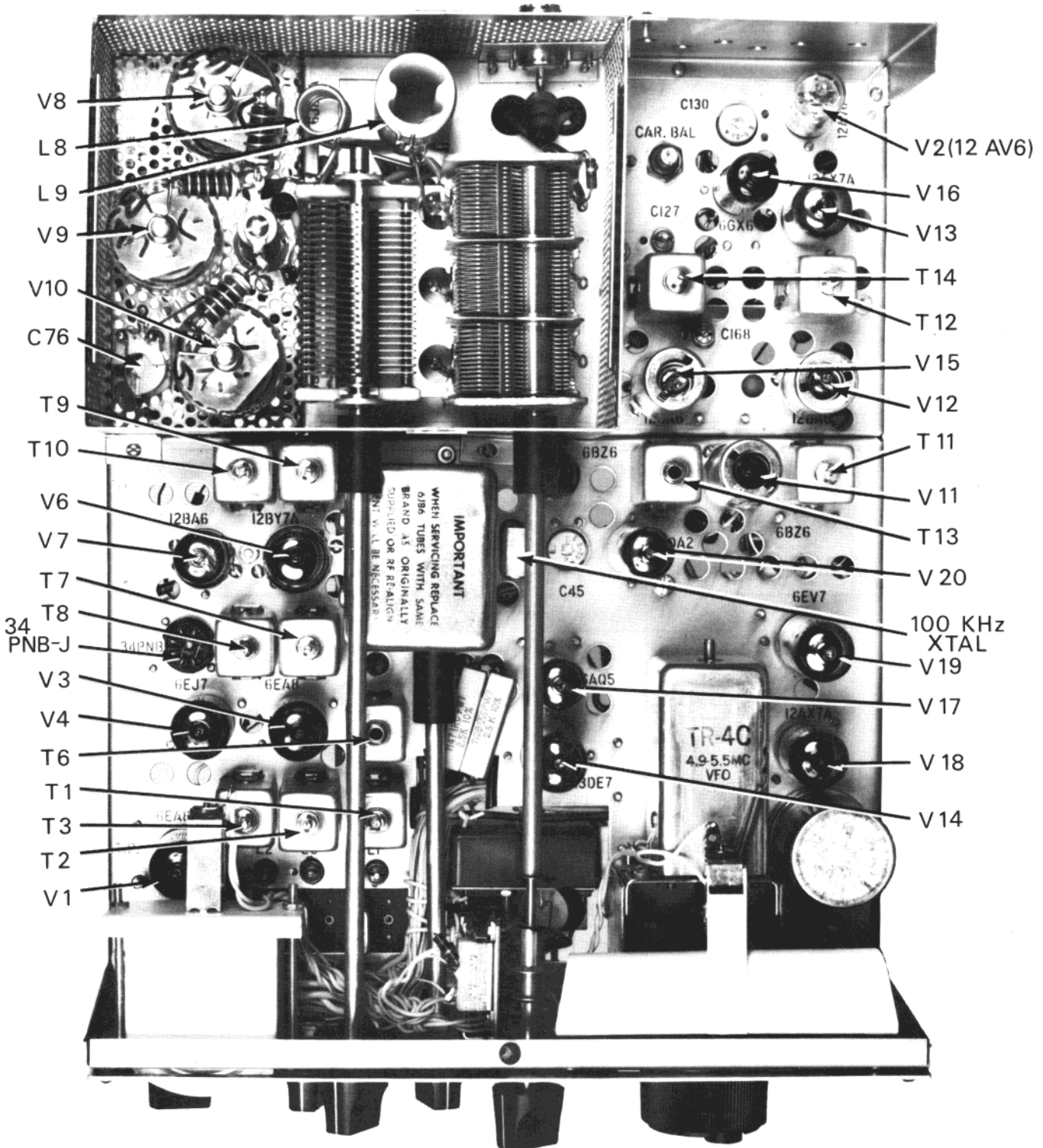

Figure 5-1. Alignment Locations, Top View

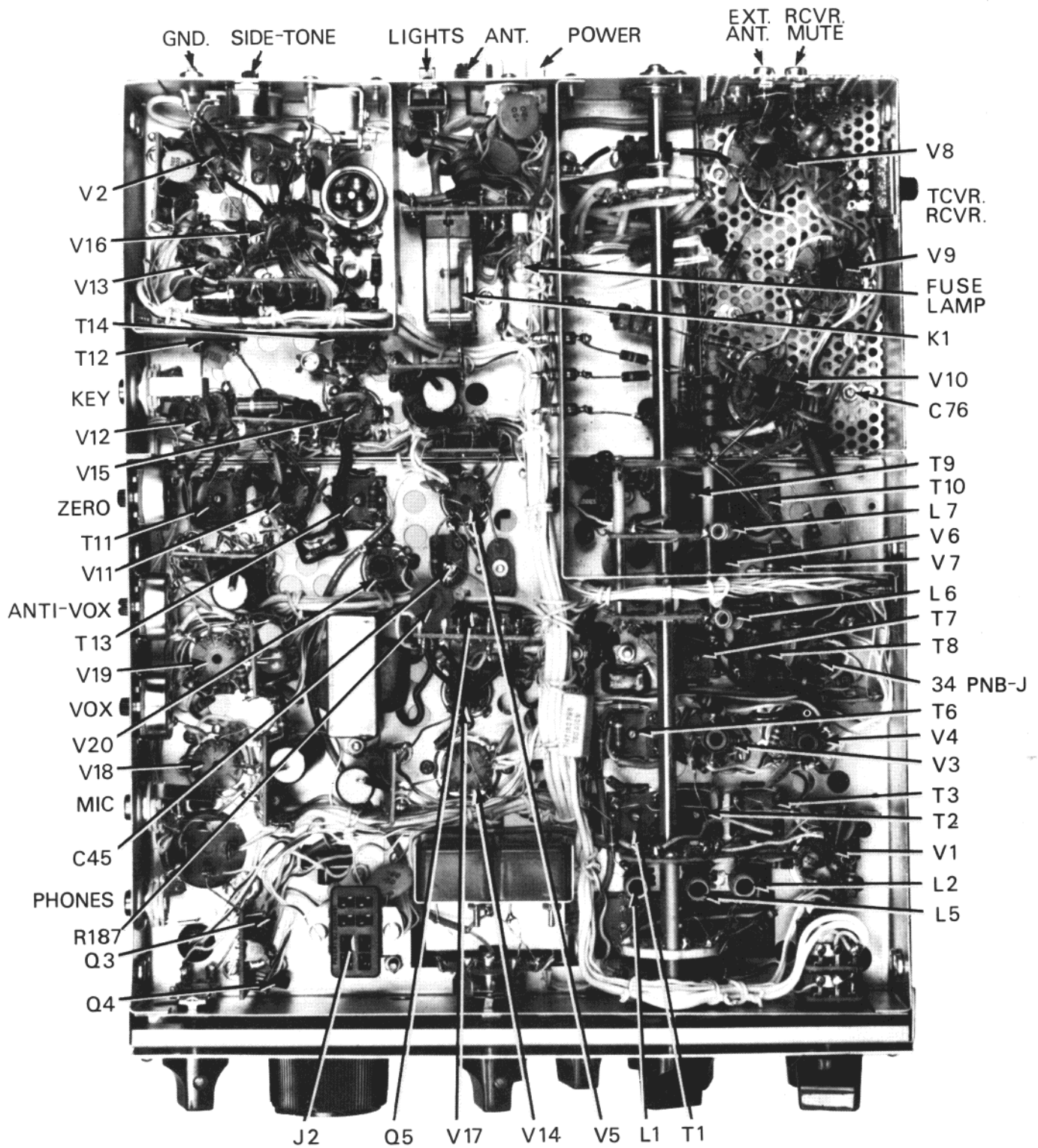
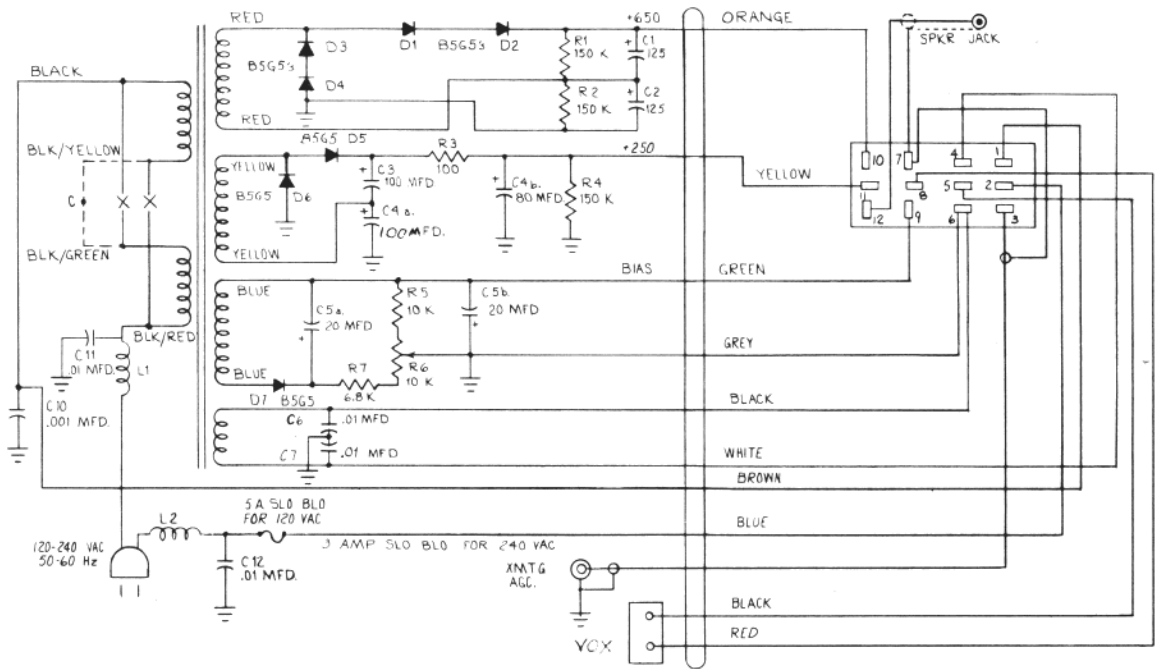

Figure 5-2. Alignment Locations, Bottom View



NOTE:
 FOR 240 VAC OPERATION DISCONNECT
 WIRES MARKED —X— AND
 CONNECT —C— AN EXTRA TERMINAL
 IS PROVIDED FOR CONNECTION C.

MODEL AC-4 POWER SUPPLY

Figure 5-3. AC-4 Power Supply Schematic

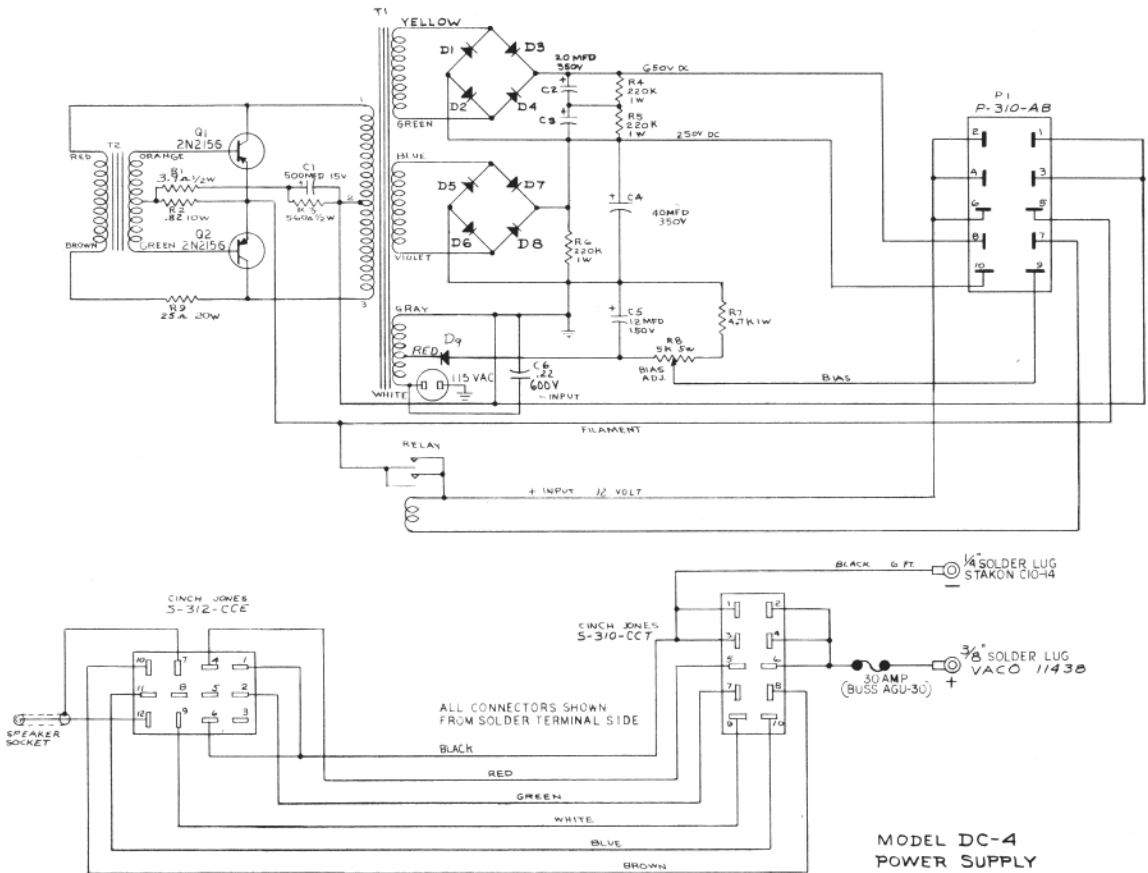

MODEL DC-4
 POWER SUPPLY

8 FEET 6 CONDUCTOR CABLE
 BELDEN B44G

Figure 5-4. DC-4 Power Supply Schematic

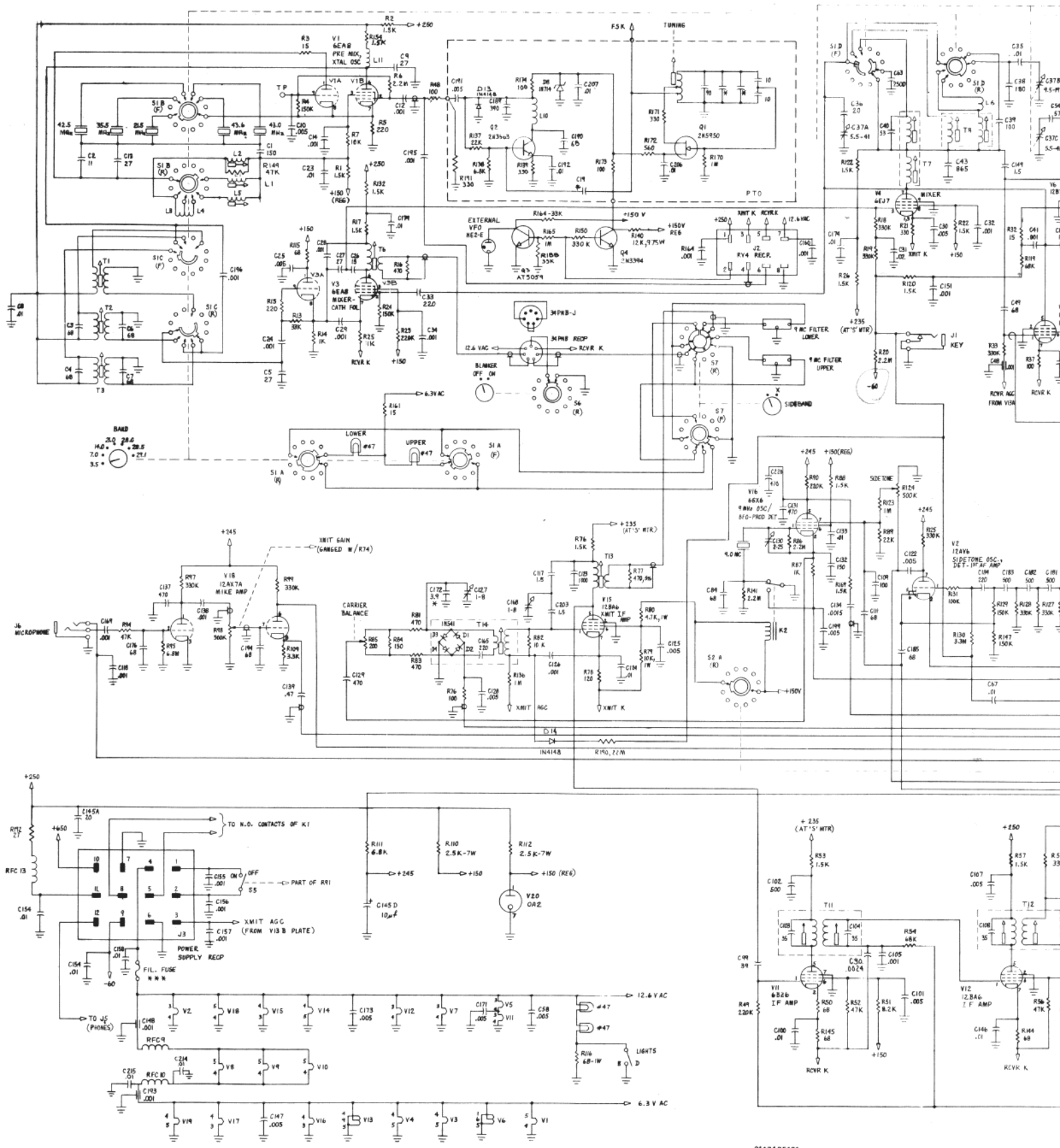

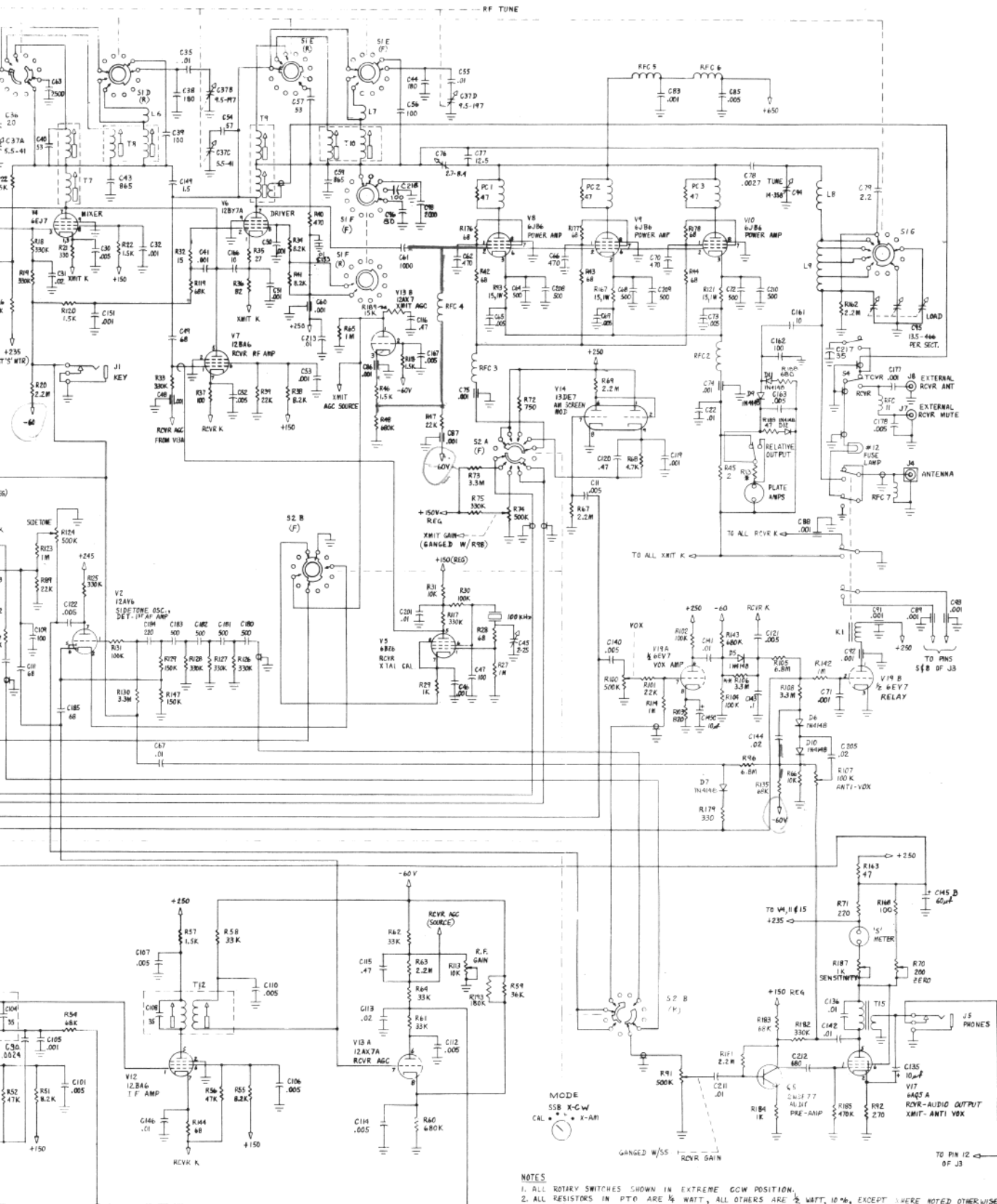

NOTES

1. ALL ROTARY SWITCHES SHOWN IN EXTREME CCW POSITION.
 2. ALL RESISTORS IN P.T.O. ARE 1/2 WATT, ALL OTHERS ARE 1/4 WATT, 10%, EXCEPT WHERE NOTED OTHERWISE.
 3. CAPACITOR VALUES FROM 1 TO 1001 ARE IN PF, & THOSE FROM .001 AND UP ARE IN μ F.
 4. HIGHEST RESISTOR R1193
 5. HIGHEST CAPACITOR C220
- * VALUE SELECTED IN PRODUCTION.
 ** ADJUST TO CHANGE VOX HOLDING TIME.
 *** FILAMENT FUSE IS A 1/2" LENGTH OF #26 TINNED WIRE

Figure 5-5. TR-4C Schematic